



US011145059B2

(12) **United States Patent**
Yao et al.

(10) **Patent No.:** **US 11,145,059 B2**
(45) **Date of Patent:** **Oct. 12, 2021**

(54) **MEDICAL SCAN VIEWING SYSTEM WITH ENHANCED TRAINING AND METHODS FOR USE THEREWITH**

(71) Applicant: **Enlitic, Inc.**, San Francisco, CA (US)

(72) Inventors: **Li Yao**, San Francisco, CA (US); **Kevin Lyman**, Fords, NJ (US); **Ashwin Jadhav**, San Francisco, CA (US); **Eric C. Poblenz**, Palo Alto, CA (US); **Anthony Upton**, Malvern (AU)

(73) Assignee: **Enlitic, Inc.**, San Francisco, CA (US)

(*) Notice: Subject to any disclaimer, the term of this patent is extended or adjusted under 35 U.S.C. 154(b) by 0 days.

(21) Appl. No.: **16/941,937**

(22) Filed: **Jul. 29, 2020**

(65) **Prior Publication Data**

US 2020/0357118 A1 Nov. 12, 2020

Related U.S. Application Data

(63) Continuation-in-part of application No. 16/299,644, filed on Mar. 12, 2019, now Pat. No. 10,943,681.
(Continued)

(51) **Int. Cl.**
G06T 7/00 (2017.01)
G06K 9/32 (2006.01)
(Continued)

(52) **U.S. Cl.**
CPC **G06T 7/0012** (2013.01); **G06K 9/3233** (2013.01); **G06K 9/6256** (2013.01); **G06N 7/005** (2013.01); **G06T 7/187** (2017.01)

(58) **Field of Classification Search**
CPC G06T 7/0012; G06T 7/187; G06K 9/3233; G06K 9/6256; G06N 7/005
(Continued)

(56) **References Cited**

U.S. PATENT DOCUMENTS

6,466,687 B1 10/2002 Uppaluri et al.
6,524,246 B1 2/2003 Kelly et al.

(Continued)

FOREIGN PATENT DOCUMENTS

CN 106295139 A 1/2017
CN 106551704 A 4/2017
KR 20100014065 A 2/2010

OTHER PUBLICATIONS

Andersch, Michael; Inference: The Next Step in GPU-Accelerated Deep Learning; <https://devblogs.nvidia.com/parallelforall/inference-next-step-gpu-accelerated-deep-learning/>; Nov. 11, 2015; 7 pages.

(Continued)

Primary Examiner — Michael R Neff

(74) *Attorney, Agent, or Firm* — Garlick & Markison; Bruce E. Stuckman; Katherine C. Stuckman

(57) **ABSTRACT**

A multi-label generating system is configured to: store a first plurality of medical scans with corresponding global labels and a second plurality of medical scans with corresponding region labels, wherein the global labels each correspond to one of a set of abnormality classes and wherein each of the region labels correspond to one of the set of abnormality classes; generate a computer vision model by training on the first plurality of medical scans with the corresponding global labels and the second plurality of medical scans with the corresponding region labels; receive a new medical scan; generate global probability data based on the computer vision model, wherein the global probability data indicates a set of global probability values corresponding to the set of abnormality classes, and wherein each of the set of global probability values indicates a probability that a corresponding one of the set of abnormality classes is present in the new medical scan; and transmit the global probability data to a client device for display via a display device.

16 Claims, 32 Drawing Sheets

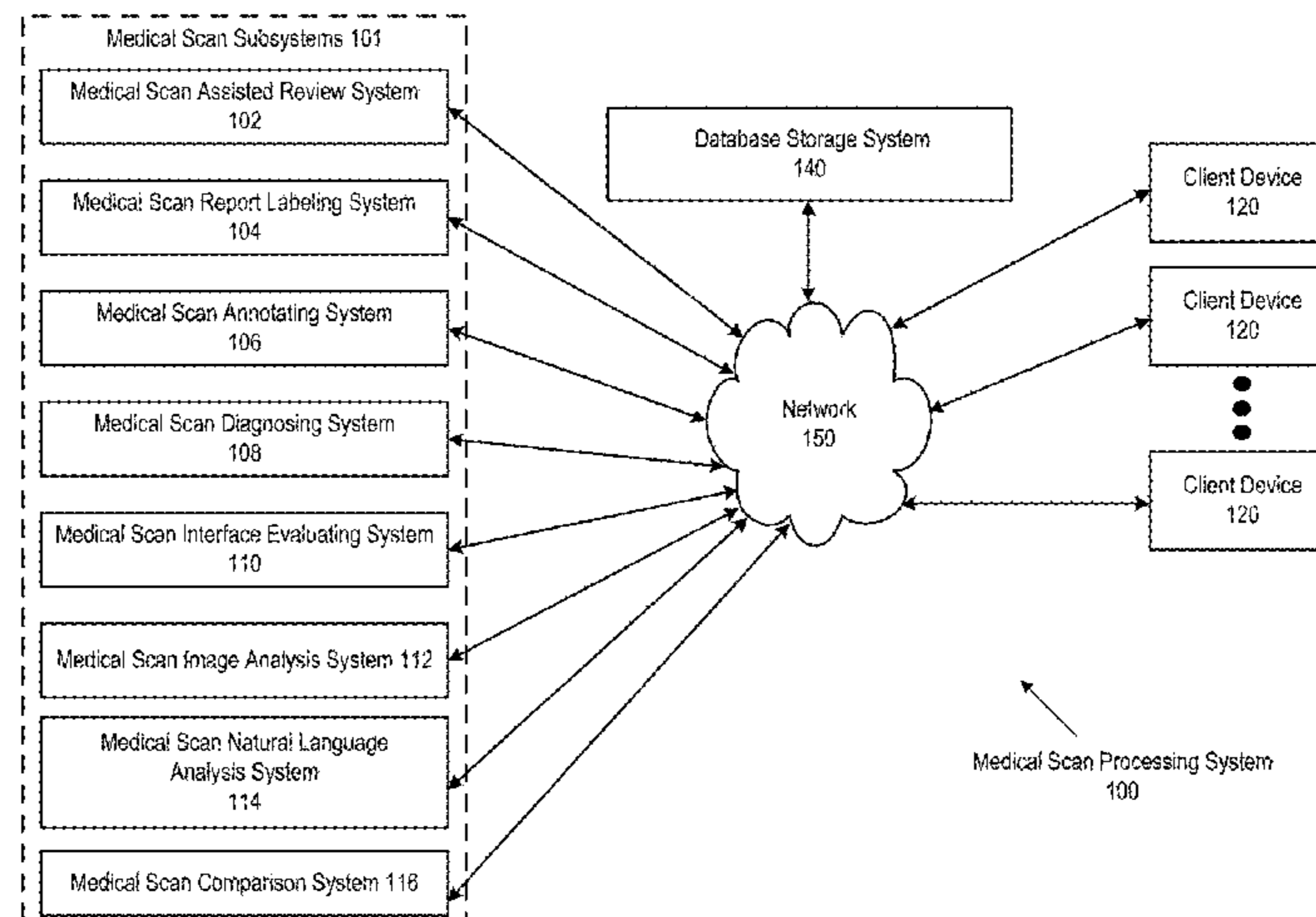

Related U.S. Application Data

- (60) Provisional application No. 62/770,334, filed on Nov. 21, 2018.
- (51) **Int. Cl.**
G06N 7/00 (2006.01)
G06K 9/62 (2006.01)
G06T 7/187 (2017.01)
- (58) **Field of Classification Search**
USPC 382/128
See application file for complete search history.

(56) **References Cited**

U.S. PATENT DOCUMENTS

6,819,790	B2	11/2004	Suzuki et al.
6,937,776	B2	8/2005	Li et al.
7,123,762	B2	10/2006	Giger et al.
7,418,123	B2	8/2008	Giger et al.
7,813,822	B1	10/2010	Hoffberg
8,121,362	B2	2/2012	Zhan et al.
8,303,505	B2	11/2012	Webler et al.
8,331,637	B2	12/2012	Bar-Aviv et al.
8,379,950	B2	2/2013	Ye et al.
8,600,133	B2	12/2013	Buelow et al.
8,885,898	B2	11/2014	Liu
9,165,360	B1	10/2015	Bates et al.
9,349,178	B1	5/2016	Itu
9,501,863	B1	11/2016	Fram et al.
9,569,736	B1	2/2017	Ghesu et al.
9,579,518	B2	2/2017	Gertner
9,760,978	B1	9/2017	Lu et al.
10,140,421	B1	11/2018	Bernard et al.
10,304,198	B2	5/2019	Yan et al.
10,340,041	B2	7/2019	Chan et al.
2002/0186818	A1	12/2002	Arnaud et al.
2003/0016850	A1	1/2003	Kaufman et al.
2004/0064029	A1	4/2004	Summers et al.
2004/0147840	A1	7/2004	Duggirala et al.
2004/0181431	A1	9/2004	Kuth et al.
2004/0252870	A1	12/2004	Reeves et al.
2005/0027566	A1	2/2005	Haskell
2005/0207630	A1	9/2005	Heang-Ping et al.
2005/0283450	A1	12/2005	Matsugu et al.
2007/0004980	A1	1/2007	Warner et al.
2008/0004505	A1	1/2008	Kapit et al.
2008/0015418	A1	1/2008	Jarrell et al.
2008/0021834	A1	1/2008	Holla et al.
2008/0205717	A1	8/2008	Reeves et al.
2008/0243539	A1	10/2008	Barish et al.
2008/0267483	A1	10/2008	Zhan et al.
2009/0177495	A1	7/2009	Abousy et al.
2009/0222388	A1	9/2009	Hua et al.
2009/0228299	A1	9/2009	Kangarloo et al.
2010/0088117	A1	4/2010	Belden et al.
2010/0278405	A1	11/2010	Kakadiaris et al.
2012/0130734	A1	5/2012	White
2013/0124527	A1	5/2013	Lee et al.
2014/0219500	A1	8/2014	Moehrle et al.
2014/0328517	A1	11/2014	Gluncic
2014/0341471	A1	11/2014	Ono et al.
2015/0031979	A1	1/2015	Rappaport et al.
2015/0063667	A1	3/2015	Sprenzc et al.
2015/0230773	A1	8/2015	Cho et al.
2015/0254843	A1	9/2015	Brown et al.
2015/0305706	A1	10/2015	Kanik et al.

2016/0019695	A1	1/2016	Chukka et al.
2016/0027175	A1	1/2016	Kim et al.
2016/0048972	A1	2/2016	Kam et al.
2016/0104281	A1	4/2016	Grady et al.
2016/0174902	A1	6/2016	Georgescu et al.
2016/0203281	A1	7/2016	Zalis et al.
2016/0260211	A1	9/2016	Gillies et al.
2016/0314588	A1	10/2016	Harper
2016/0343127	A1	11/2016	Miller et al.
2016/0350919	A1	12/2016	Steigauf et al.
2016/0364862	A1	12/2016	Reicher et al.
2017/0004619	A1	1/2017	Liang et al.
2017/0024517	A1	1/2017	Biegert et al.
2017/0068780	A1	3/2017	Dobrea
2017/0116497	A1	4/2017	Georgescu et al.
2017/0330320	A1	11/2017	Lynch et al.
2017/0337343	A1	11/2017	Kakadiaris et al.
2018/0025255	A1	1/2018	Poole et al.
2018/0033144	A1*	2/2018	Risman G16H 30/20
2018/0060535	A1	3/2018	Reicher
2018/0060691	A1	3/2018	Bernal et al.
2018/0114595	A1	4/2018	Stern
2018/0204111	A1	7/2018	Zadeh et al.
2018/0315182	A1	11/2018	Rapaka et al.
2018/0342055	A1	11/2018	Lyman et al.
2019/0142519	A1	5/2019	Siemionow et al.

OTHER PUBLICATIONS

Choi, Y., Chiu, C. Y. I., Sontag, D. (2016). Learning low-dimensional representations of medical concepts. AM IA Summits on Translational Science Proceedings, 2016, 41. (Year: 2016). International Searching Authority; International Search Report and Written Opinion; International Application No. PCT/US2018/032927; dated Sep. 14, 2018; 9 pgs.

Minnaar, Alex; Deep Learning Basics: Neural Networks, Backpropagation and Stochastic Gradient Descent; <http://alexminnaar.com/deep-learning-basics-neural-networks-backpropagation-and-stochastic-gradient-descent.html>; Feb. 14, 2015; 11 pages.

Olah, Christopher; Calculus on Computational Graphs: Backpropagation; <http://colah.github.io/posts/2015-08-Backprop/>; Aug. 31, 2015; 7 pages.

Pham, A.-D., Neveol, A., Lavergne, T., Yasunaga, D., Clement, O., Meyer, G., . . . Burgun, A. (2014). Natural language processing of radiology reports for the detection of thromboembolic diseases and clinically relevant incidental findings. BMC Bioinformatics, 15(1). doi: 10.1186/1471-2105-15-266 (Year: 2014).

Pons, E., Braun, L. M. M., Hunink, M. G. M., Kors, J. A. (2016). Natural Language Processing in Radiology: A Systematic Review. Radiology, 279(2), 329-343. doi: 10.1148/radiol.16142770.

Pre Conference Proceedings of the 7th MICCAI BraTS Challenge (2018); BraTS Multimodal Brain Tumor Segmentation Challenge; Granada, Spain; Sep. 16, 2018; 578 pages.

Reid, Stuart; 10 misconceptions about Neural Networks; <http://www.turingfinance.com/misconceptions-about-neural-networks/>; May 8, 2014; 24 pages.

“What Not to Include in a Medical Record. (Jun. 6, 2012). Retrieved from <https://www.texmed.org/Template.aspx?id=1741>. (Year: 2012)”. Wikipedia: Backpropagation; https://en.wikipedia.org/wiki/Backpropagation#Assumptions_about_the_loss_function; downloaded from the internet on 18/15/18; 12 pages.

Wikipedia; Convolutional neural network; https://en.wikipedia.org/wiki/Convolutional_neural_network#Pooling_layer; downloaded from the internet on Jan. 15, 2018; 21 pages.

Yao, Li, Analysis of focal loss with noisy labels, Dec. 2019.

* cited by examiner

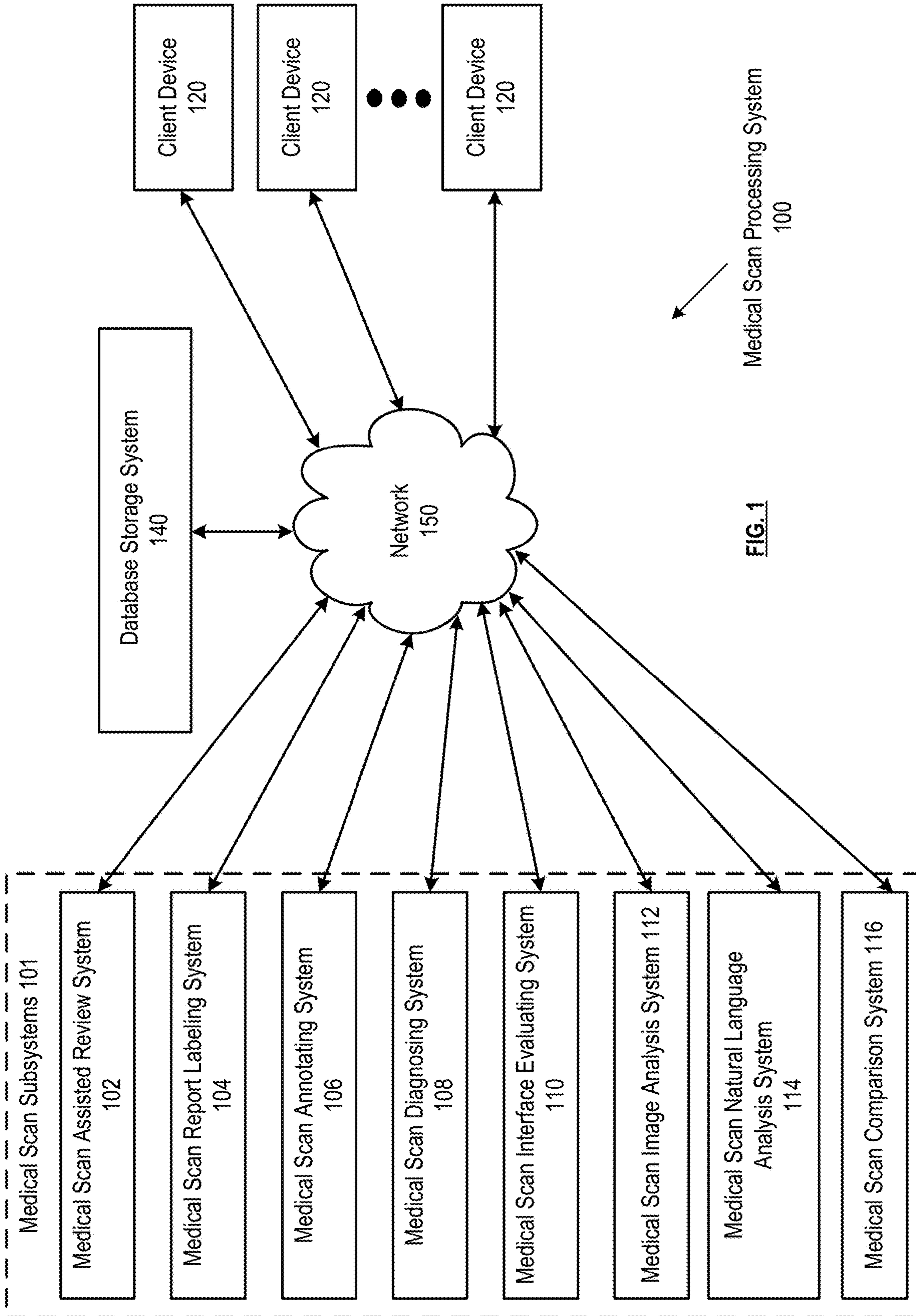

FIG. 1

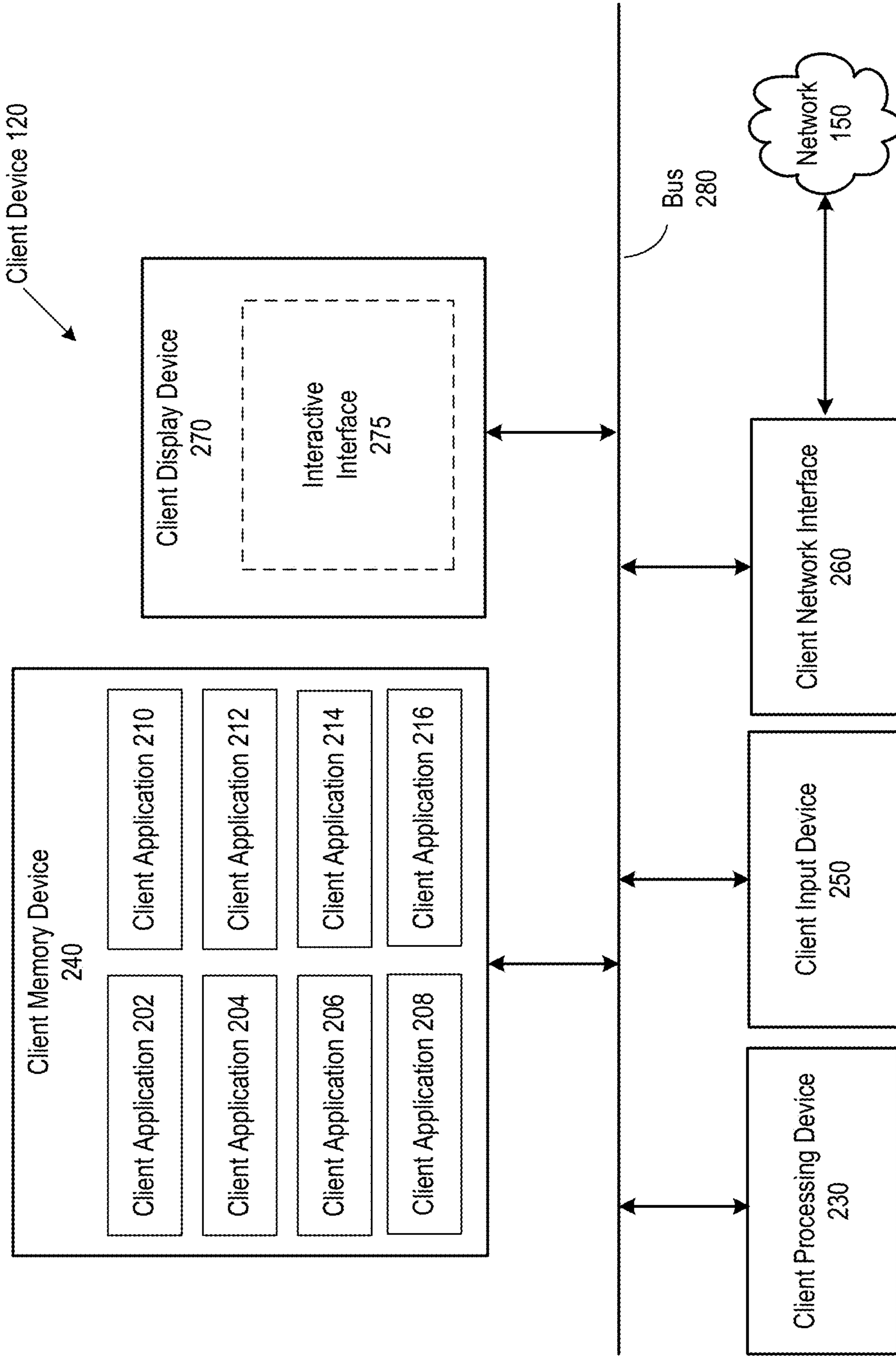

FIG. 2A

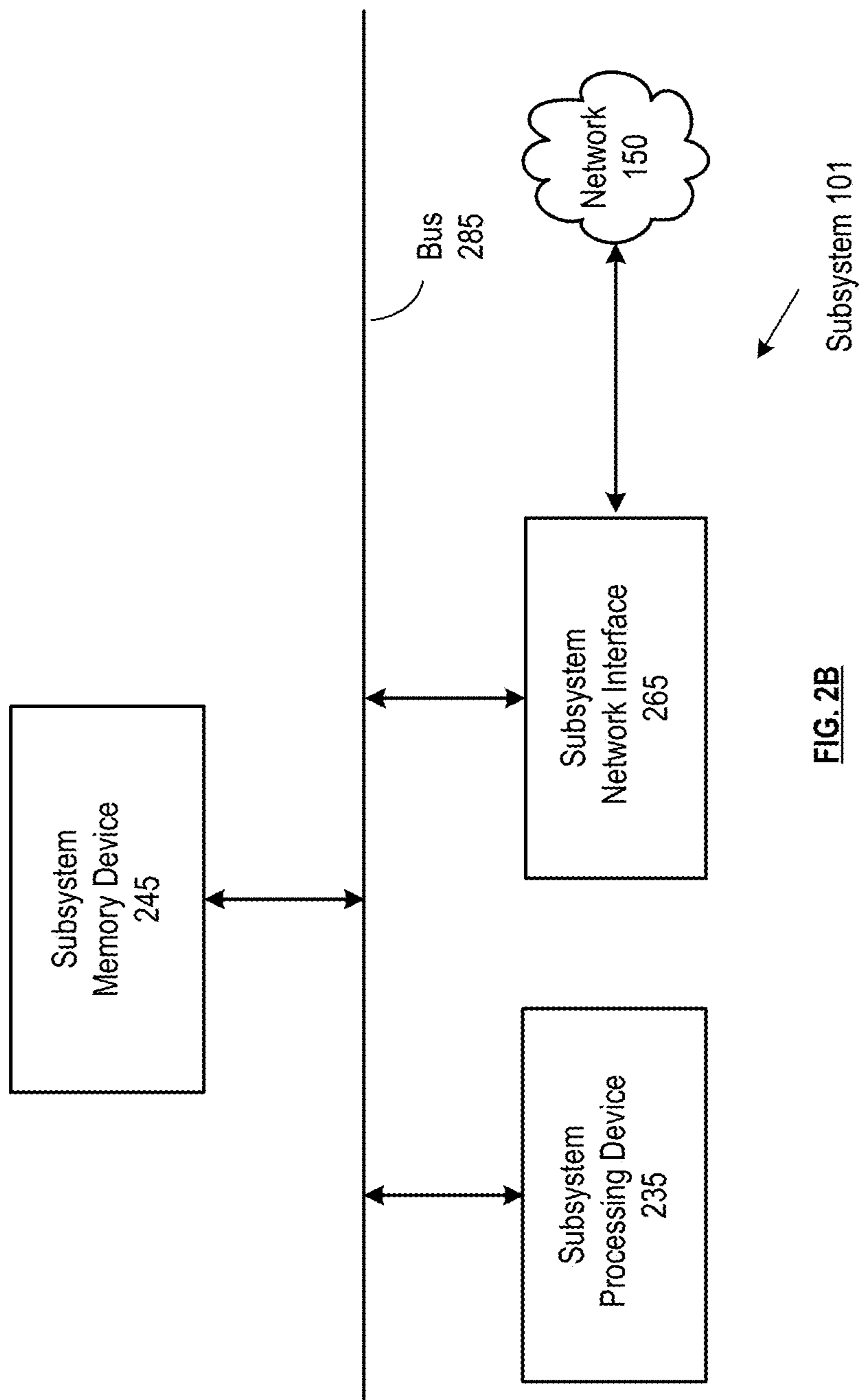

FIG. 2B

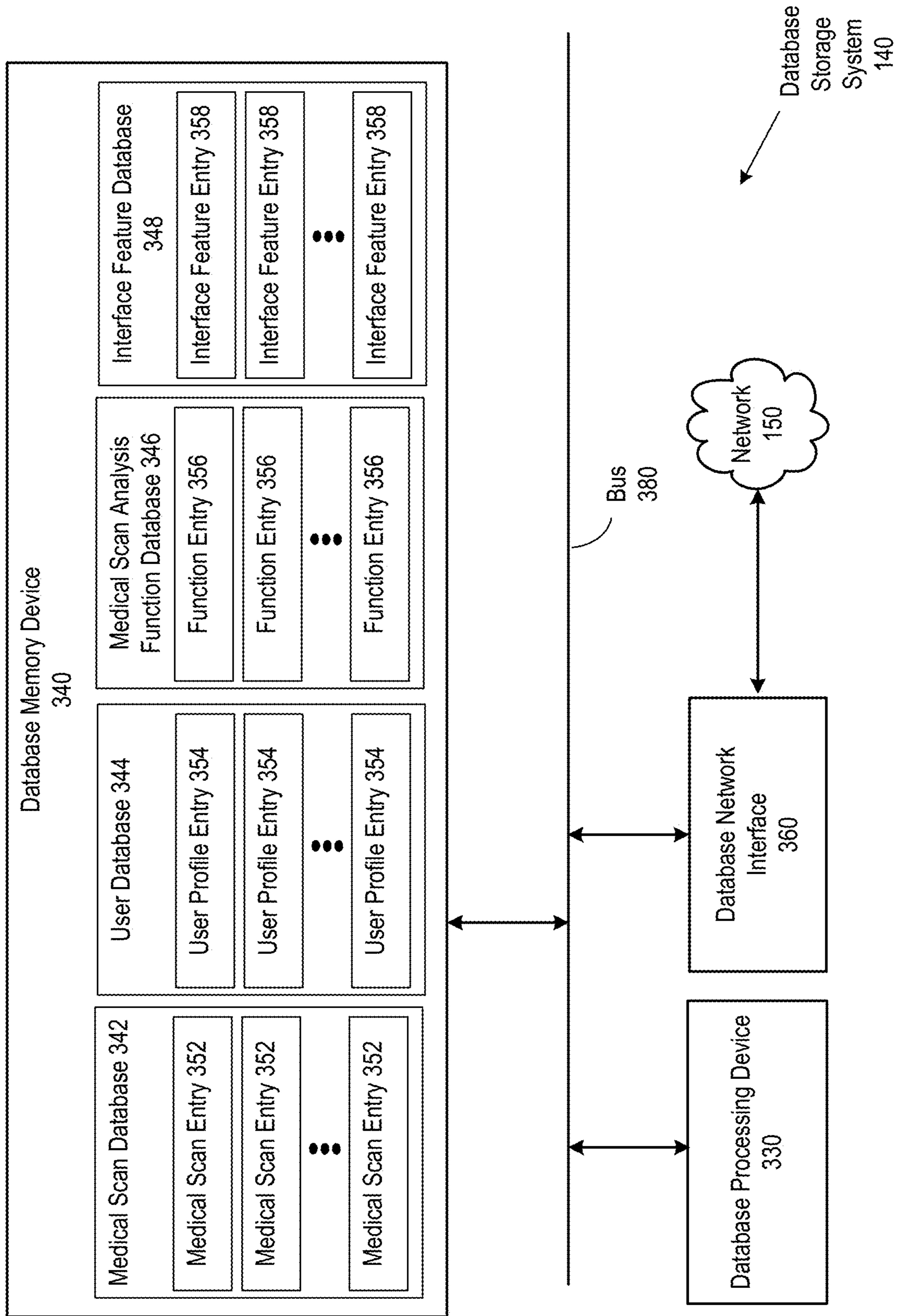

FIG. 3

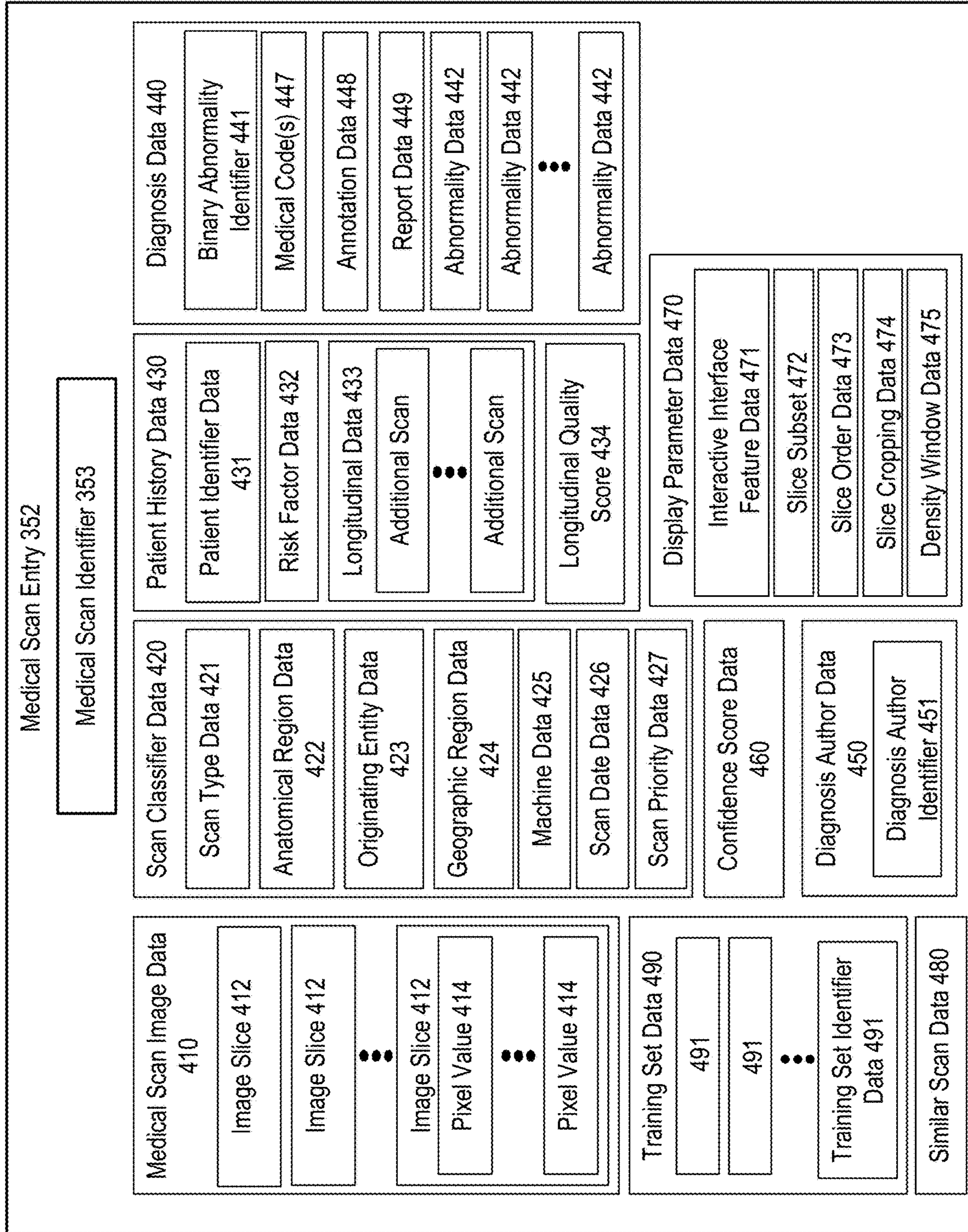

FIG. 4A

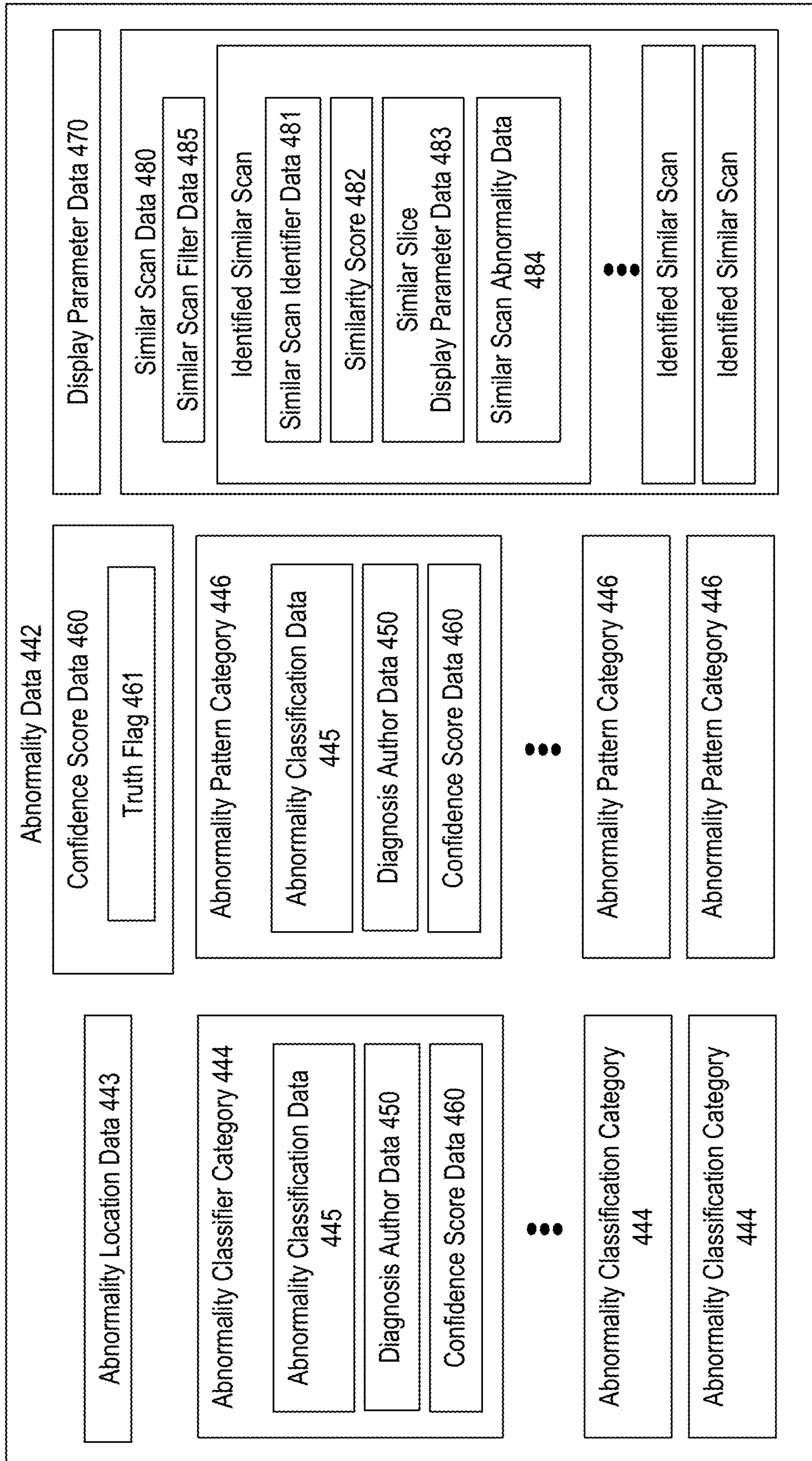

FIG. 4B

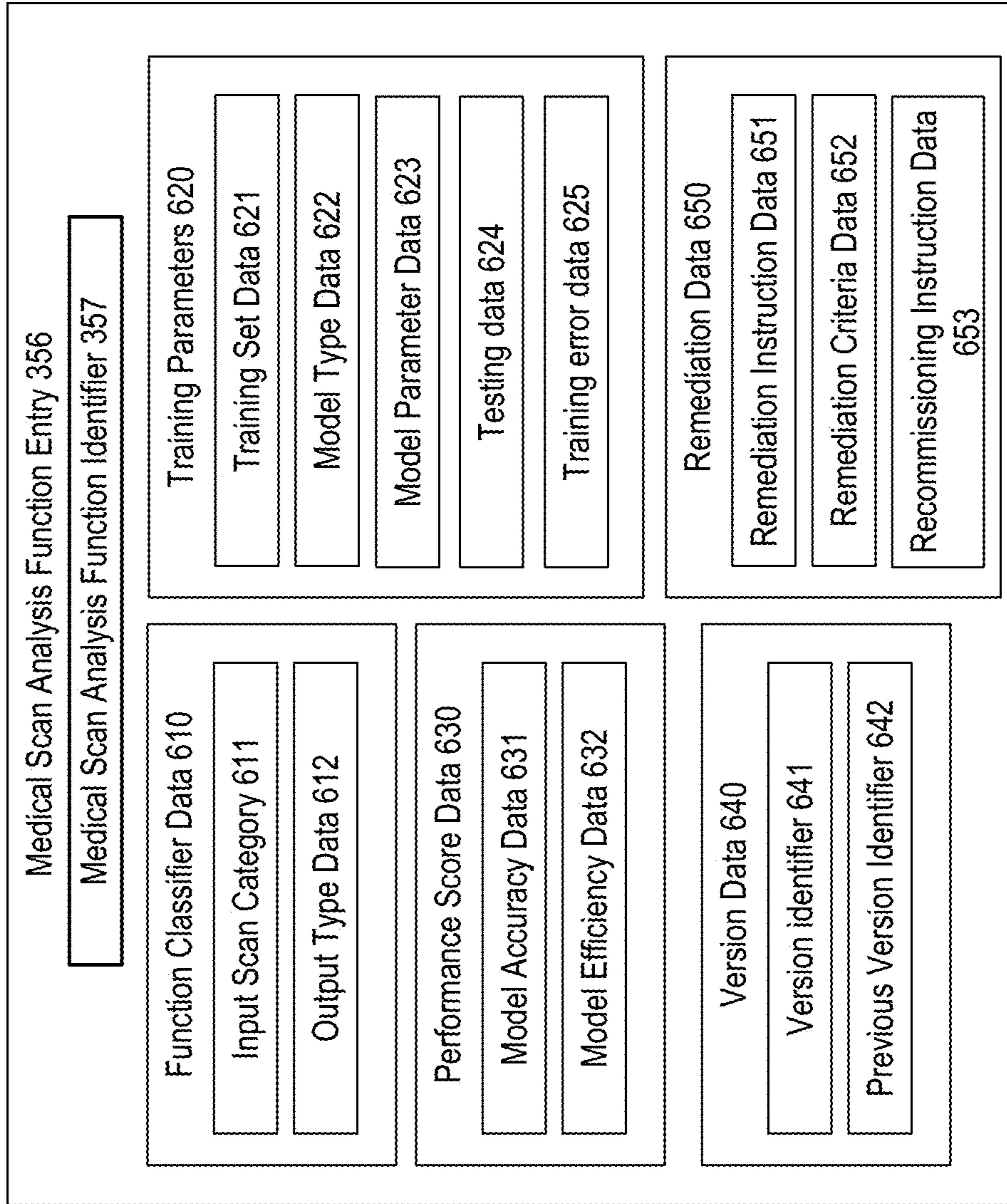

FIG. 5

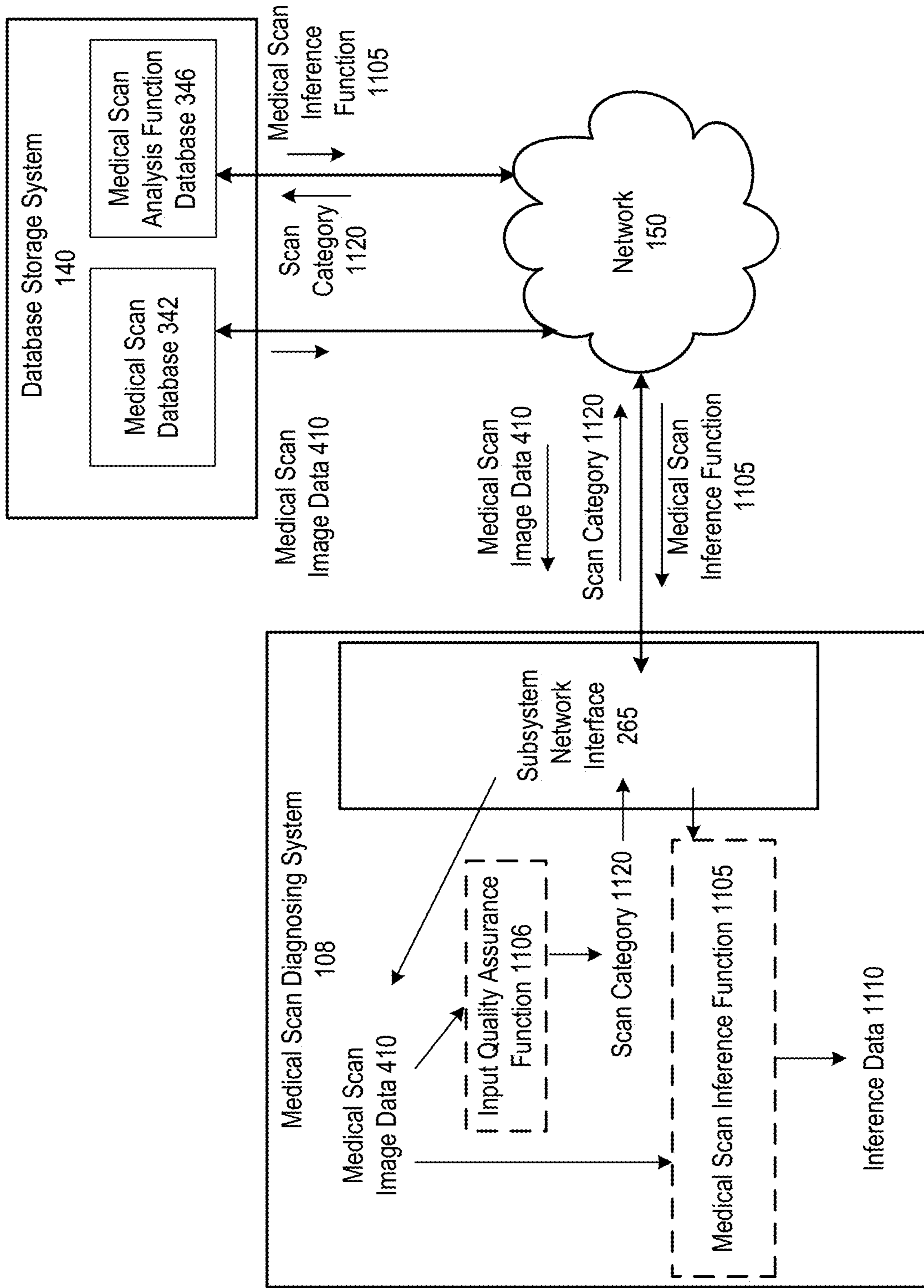

FIG. 6A

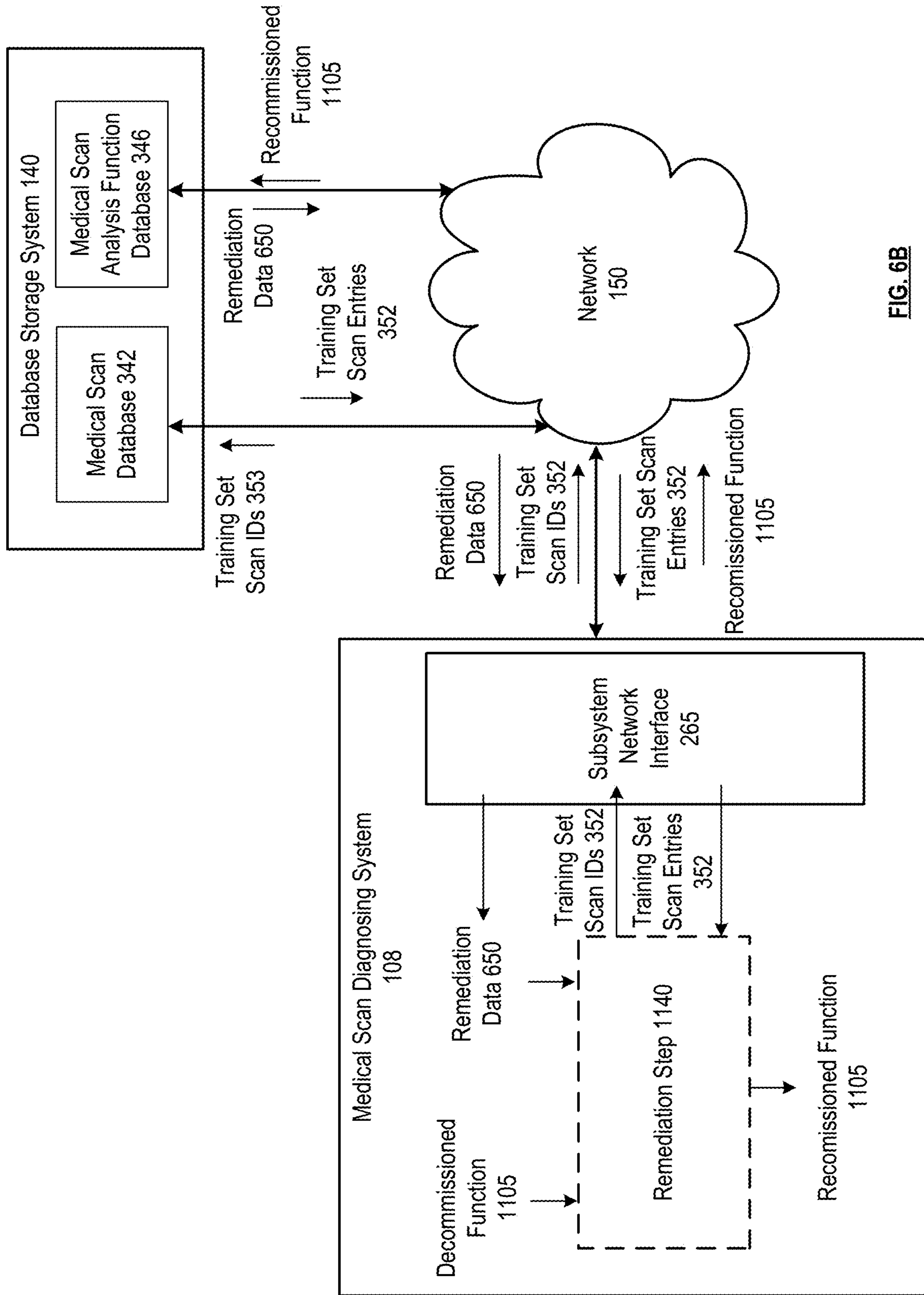

FIG. 6B

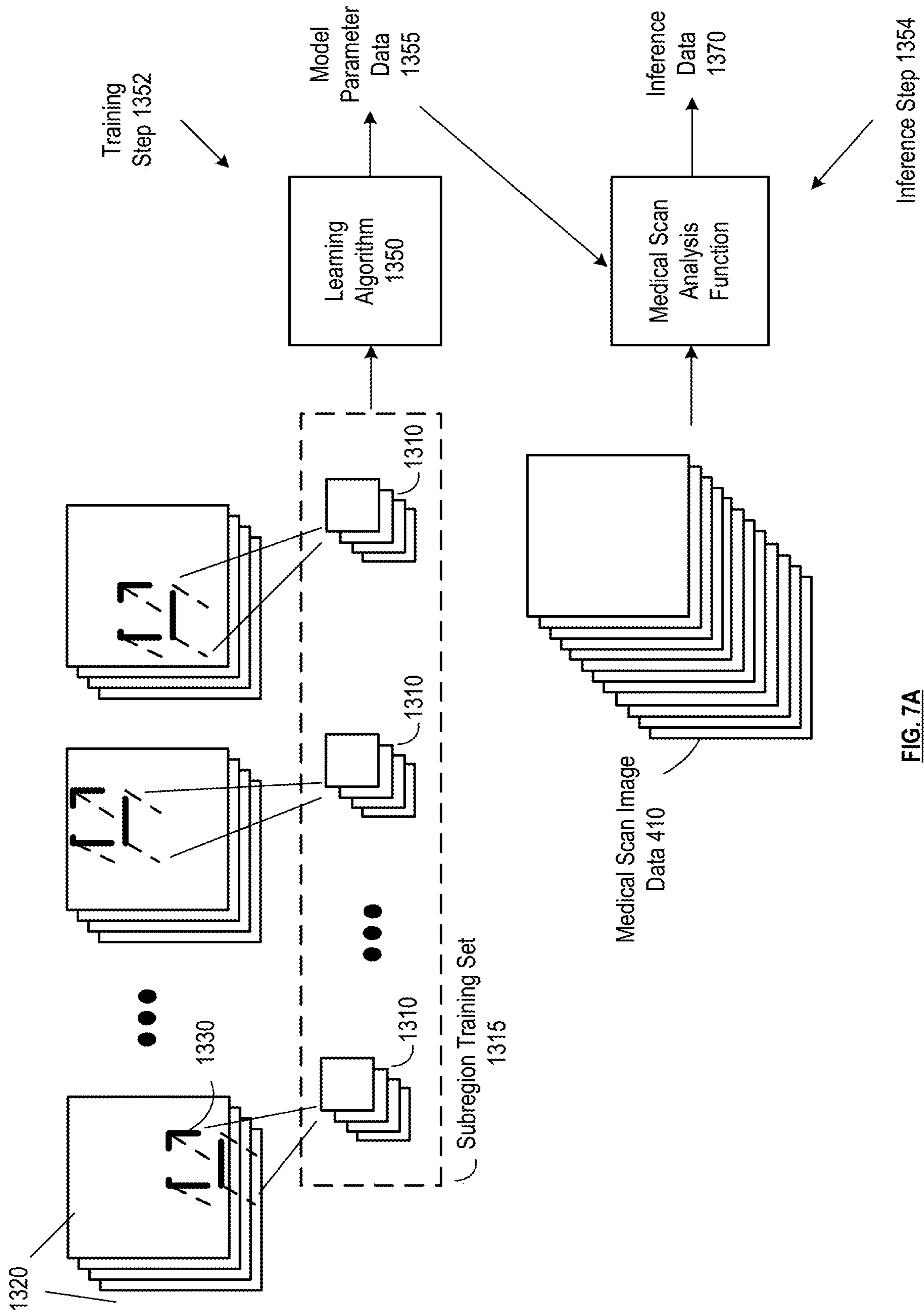

FIG. 7A

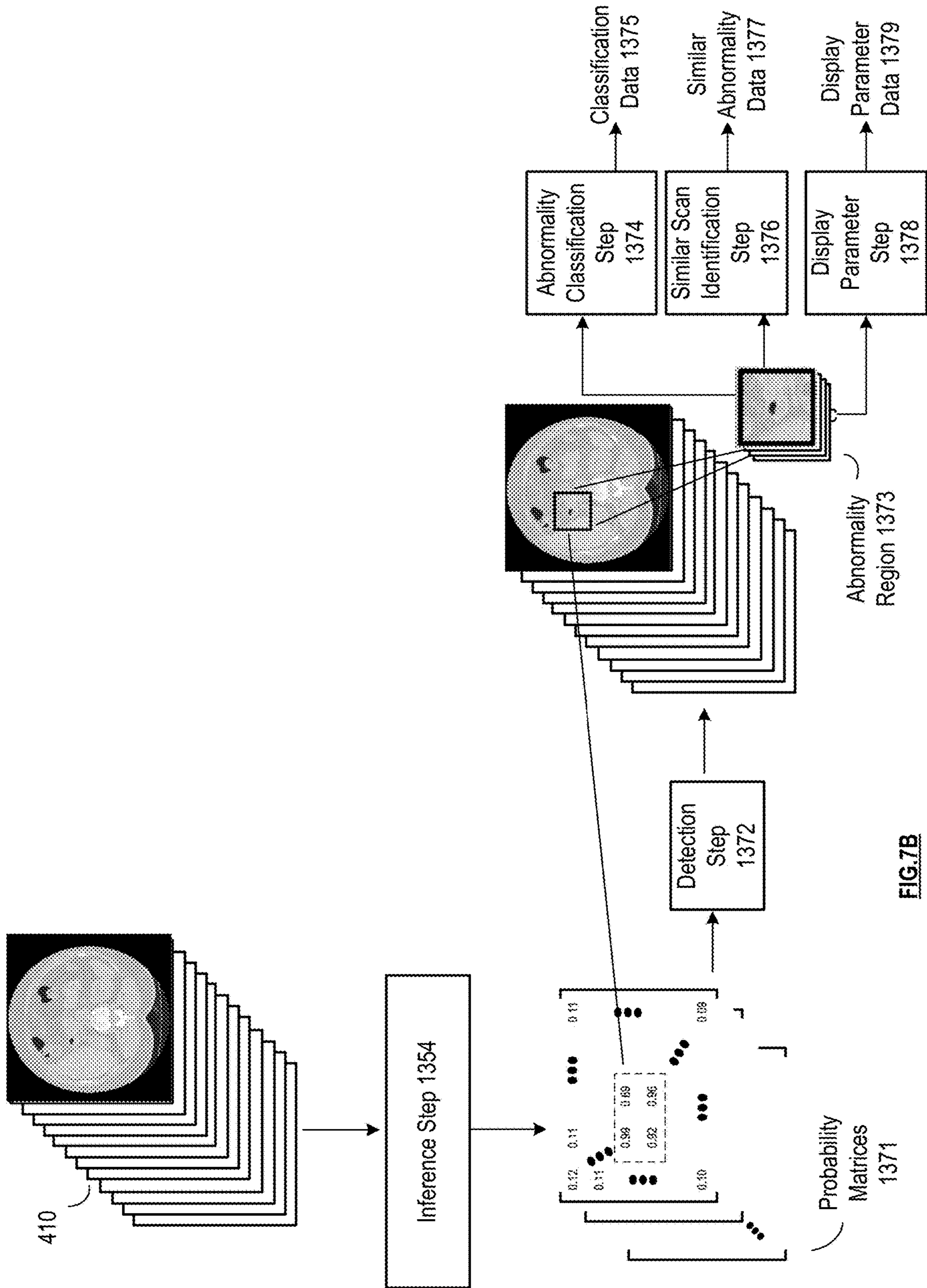

FIG.7B

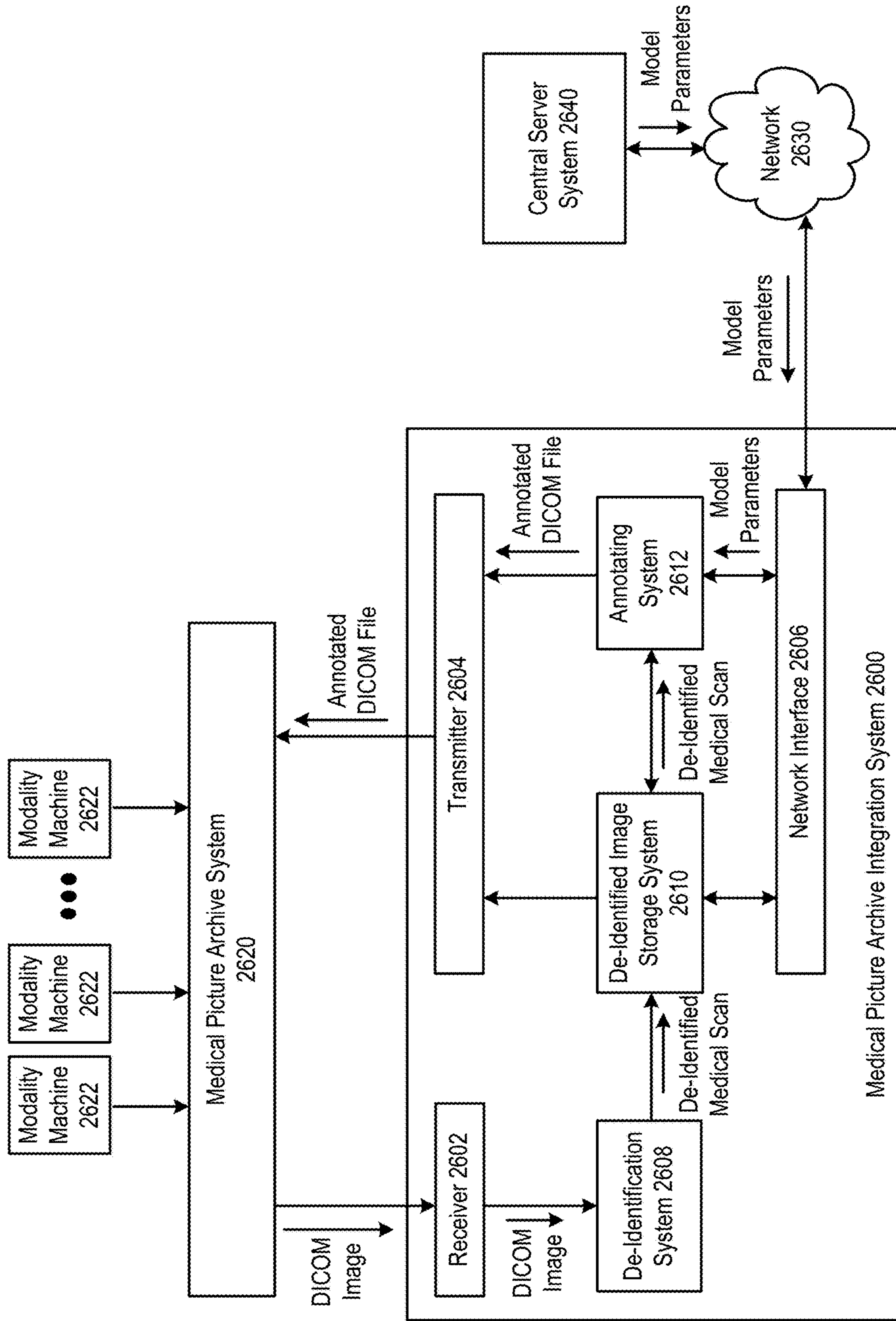

FIG. 8A

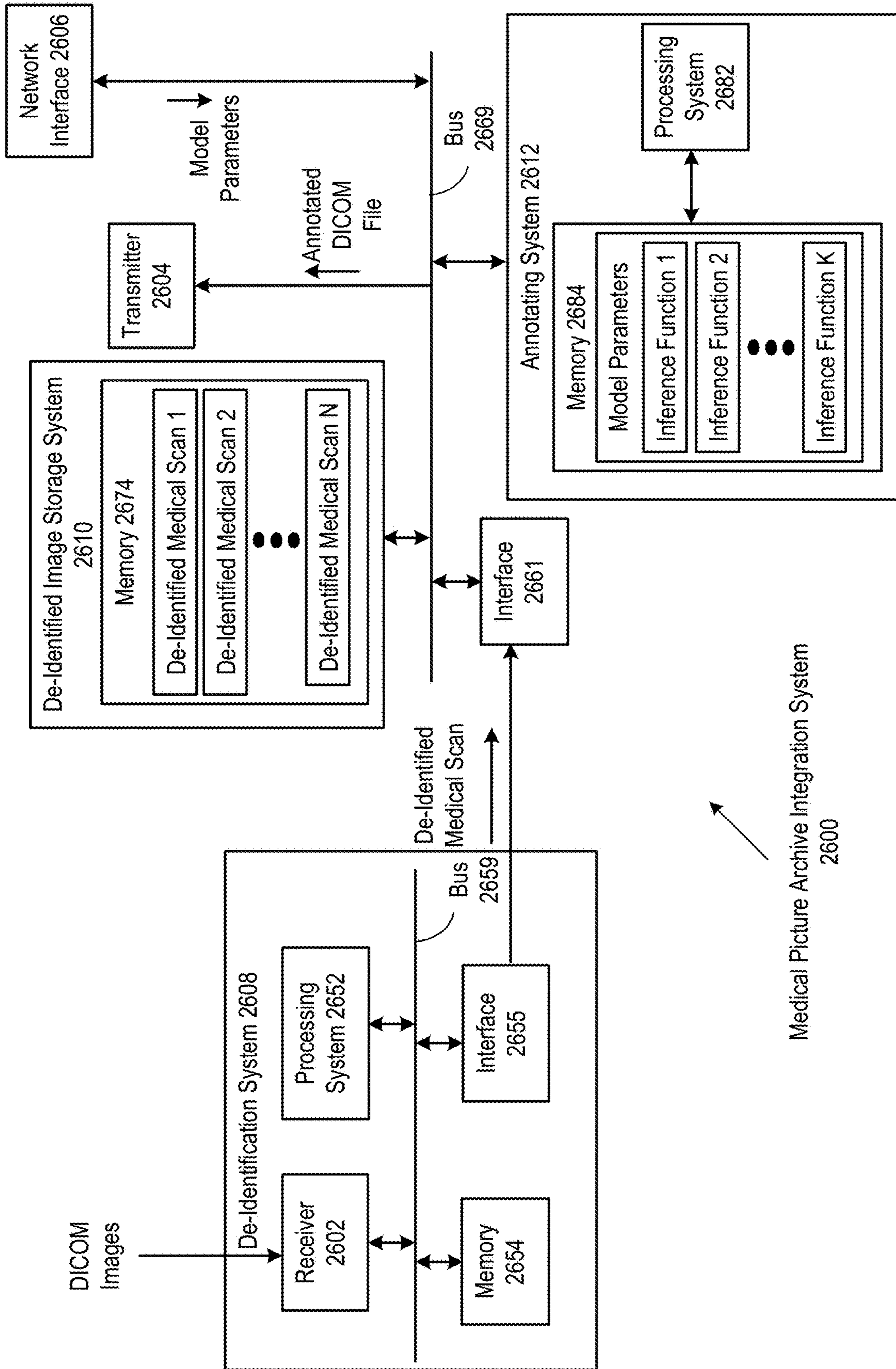

FIG. 8B

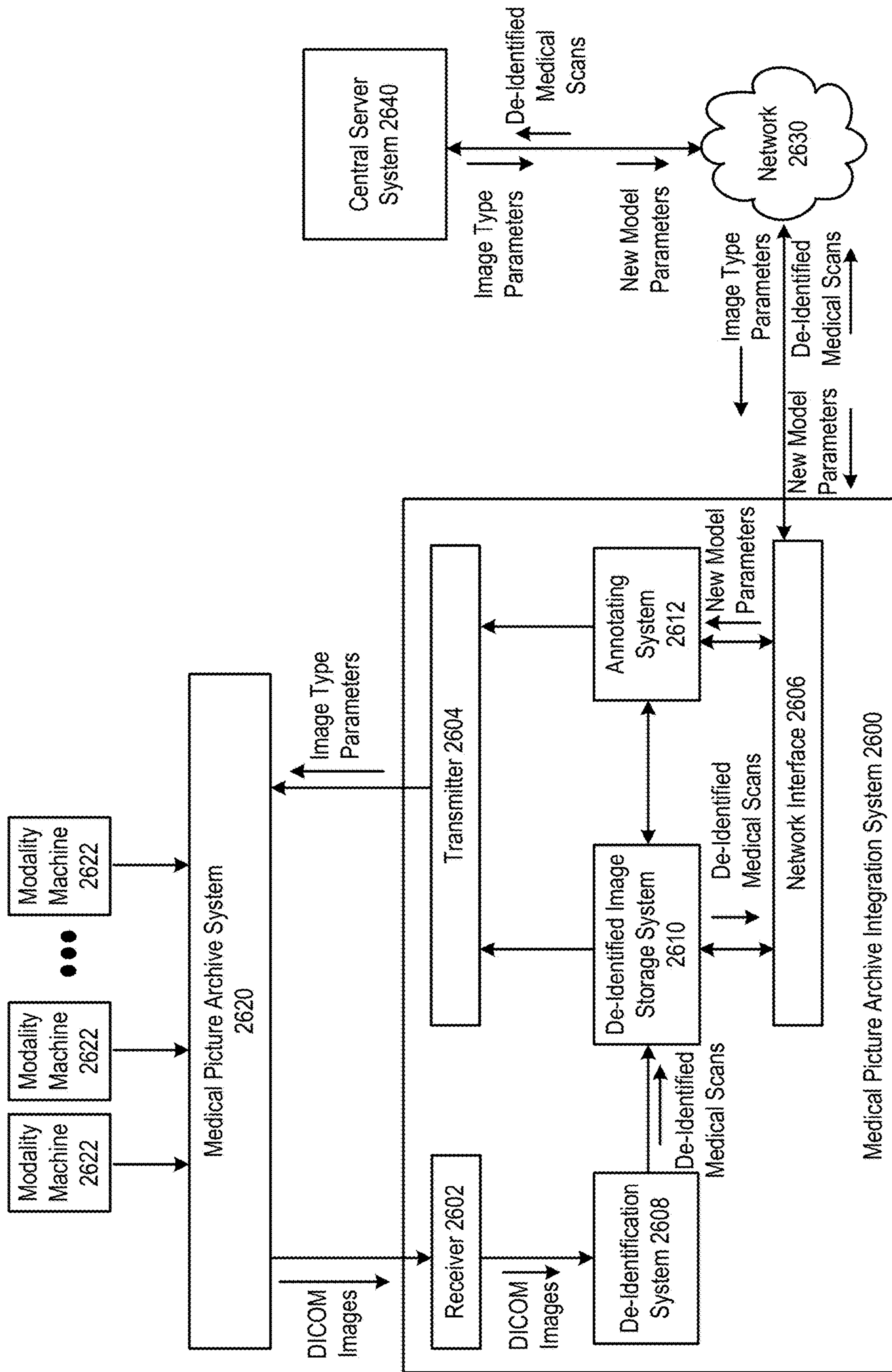

FIG. 8C

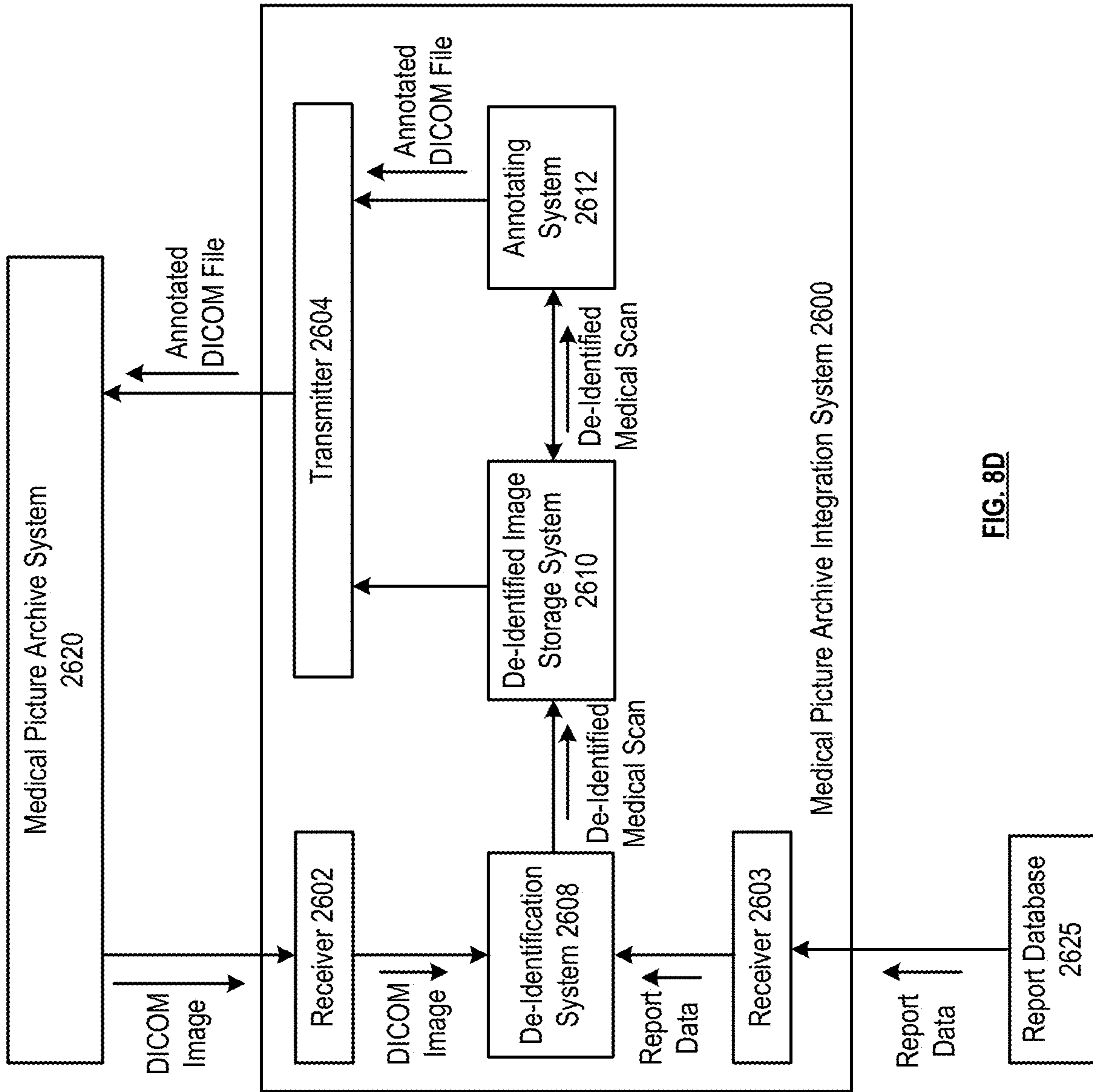

FIG. 8D

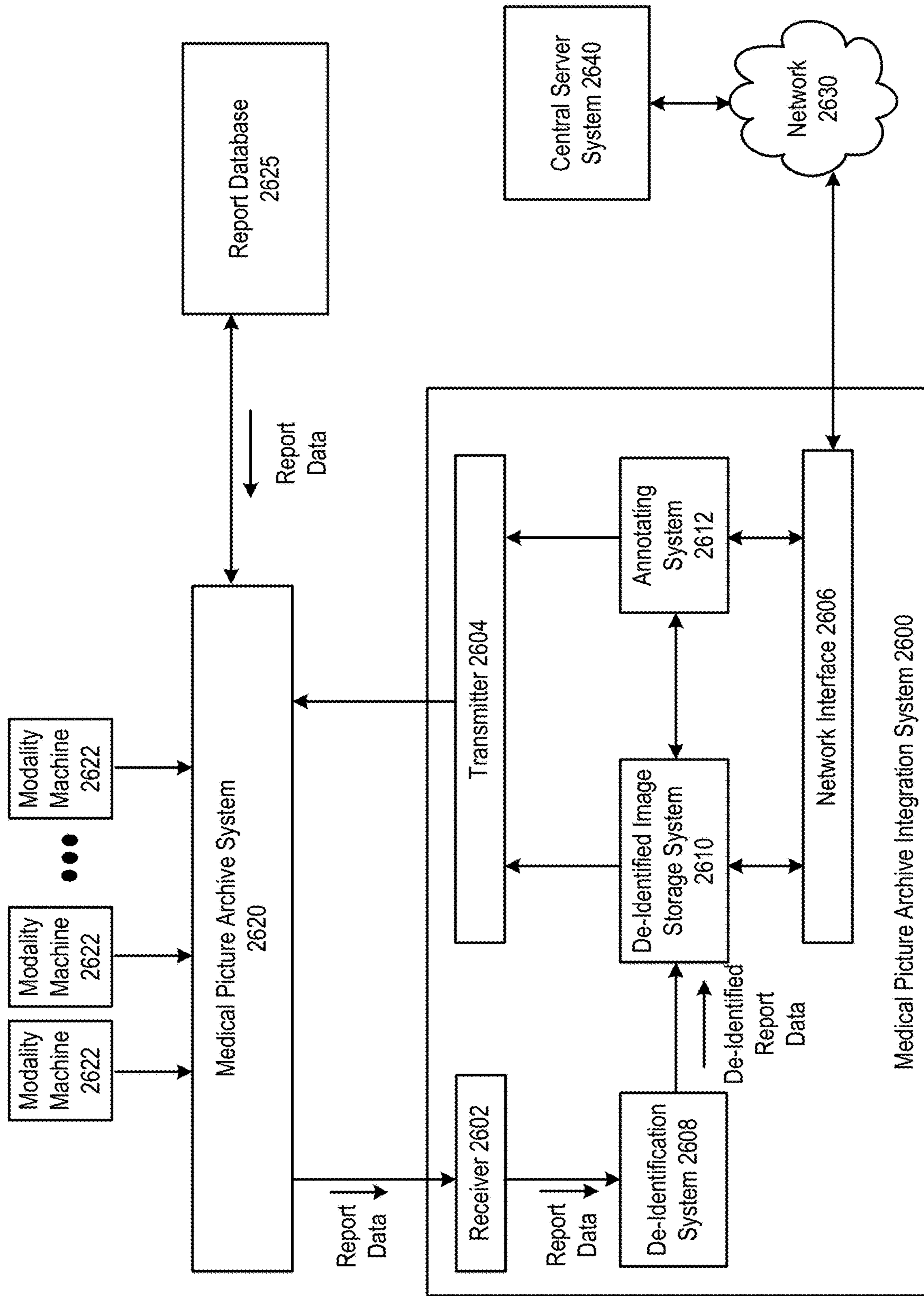

FIG. 8E

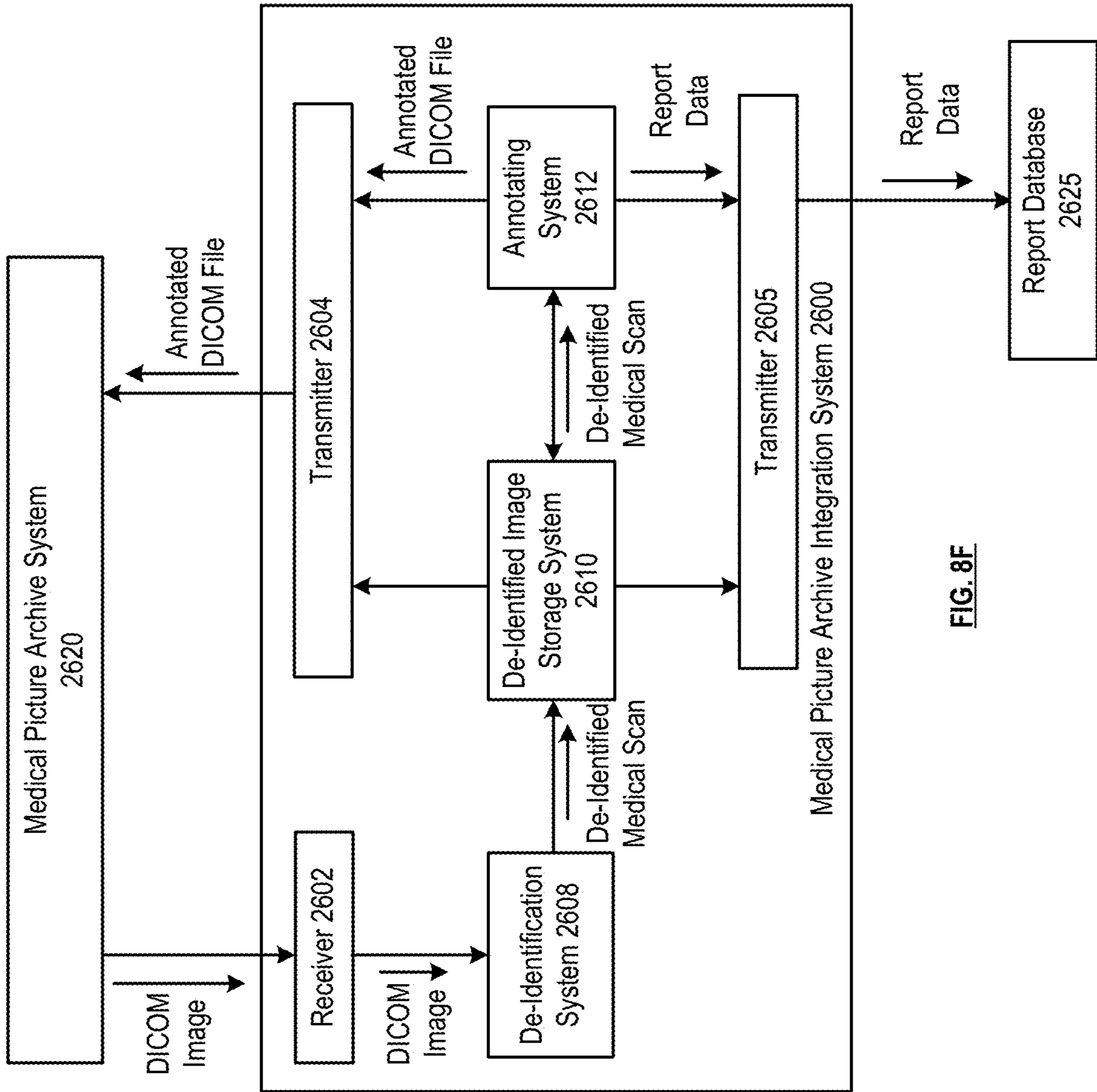

FIG. 8F

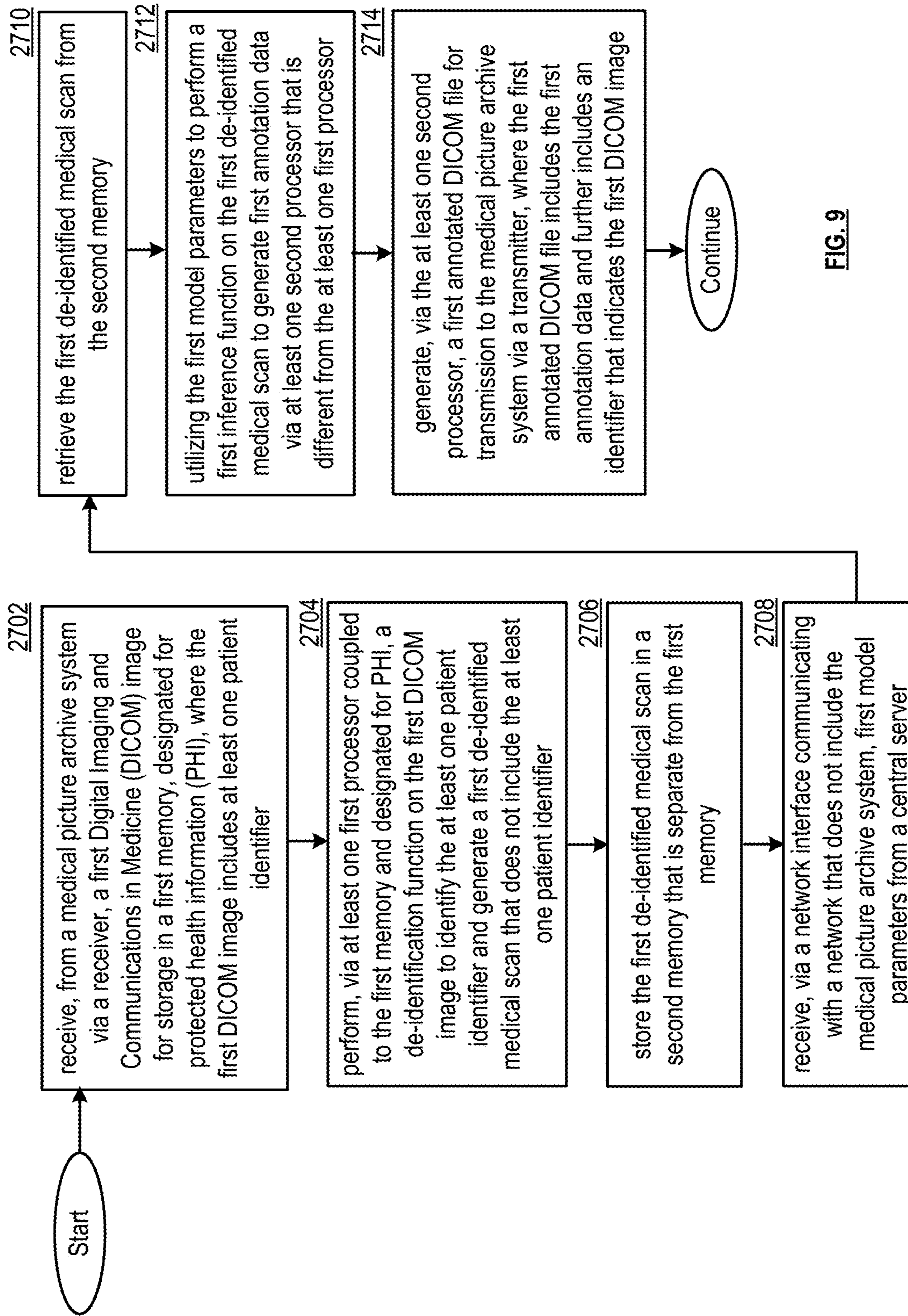

FIG. 9

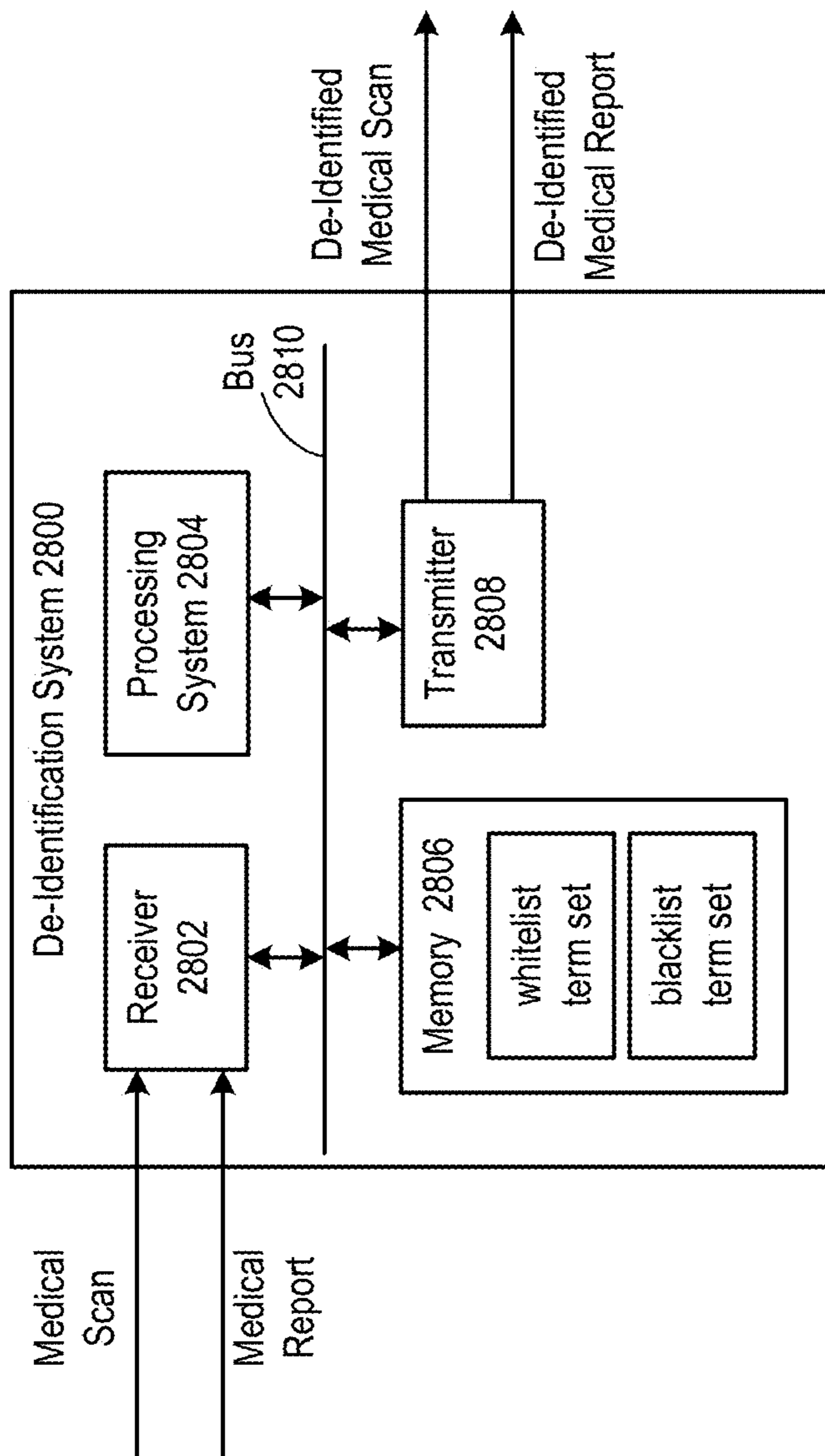

FIG. 10A



FIG. 10B

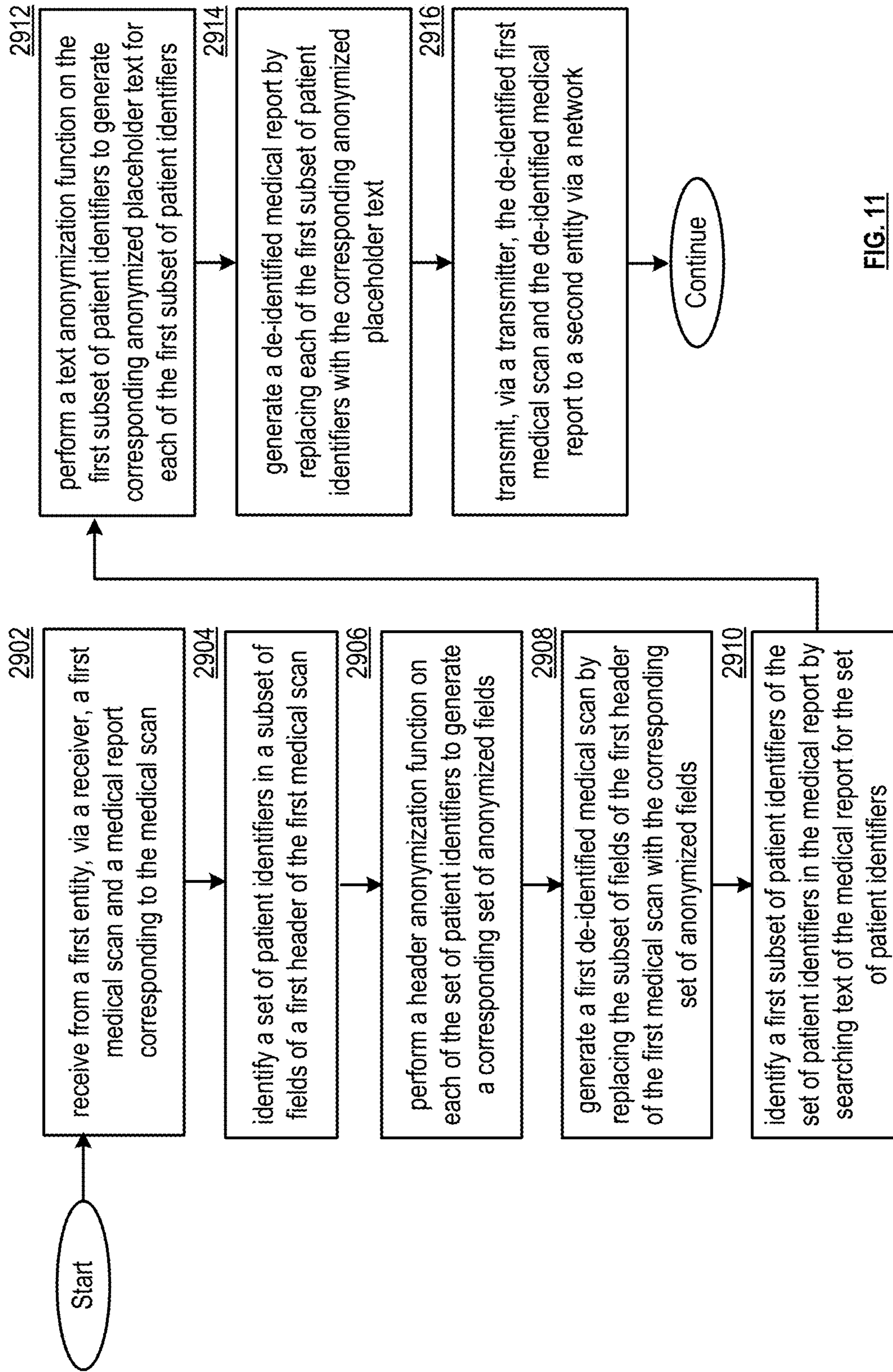

FIG. 11

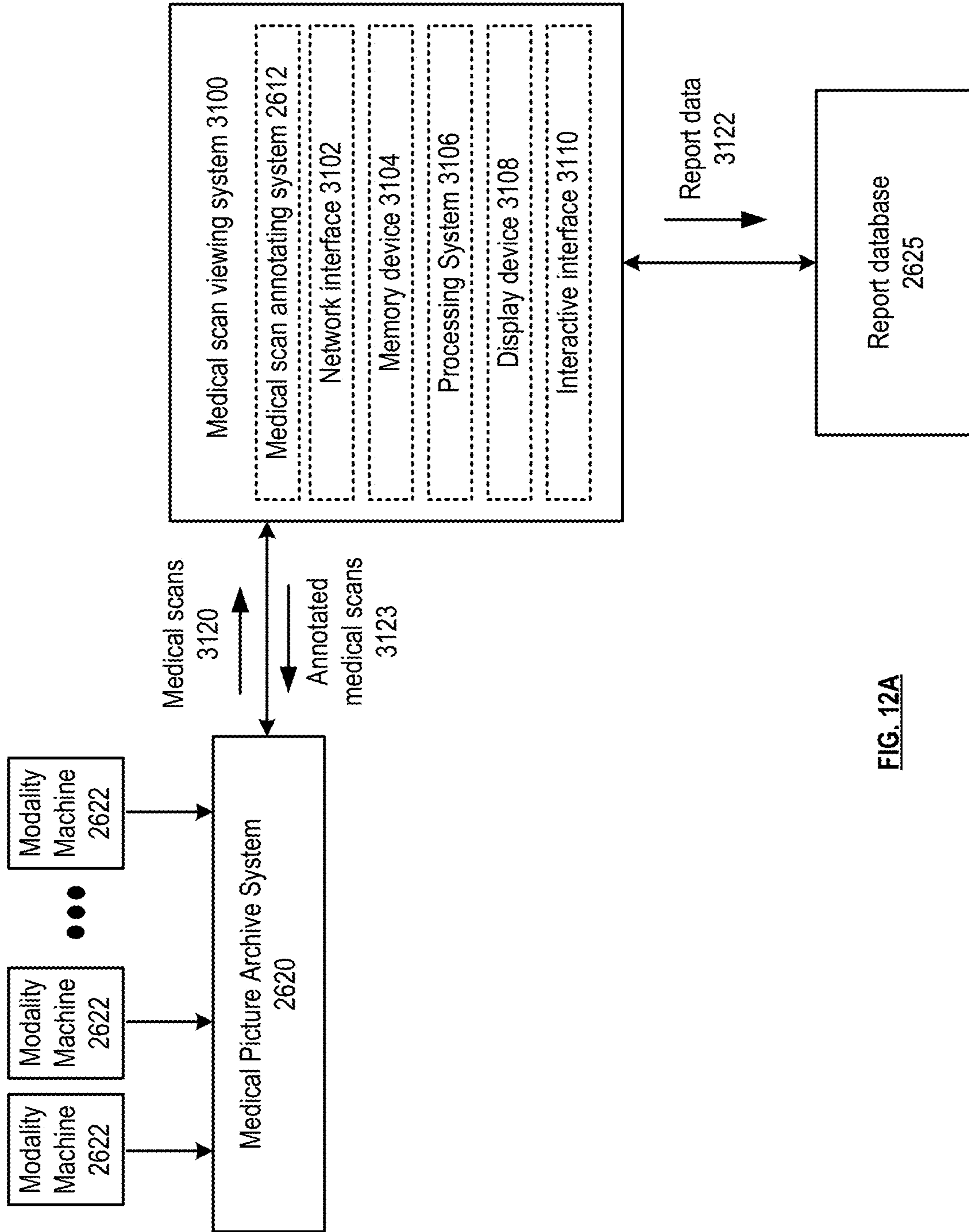

FIG. 12A

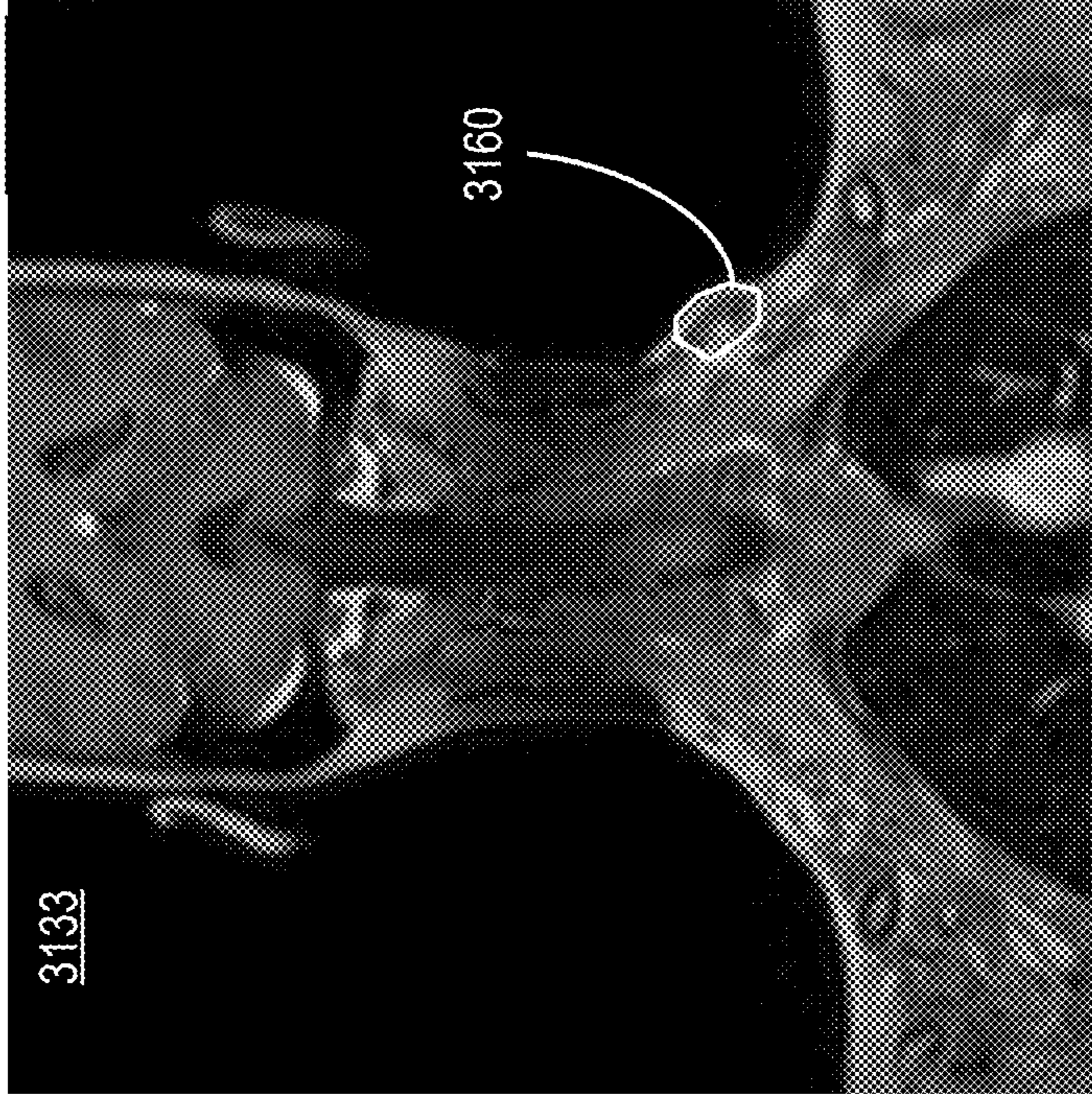

FIG. 12C

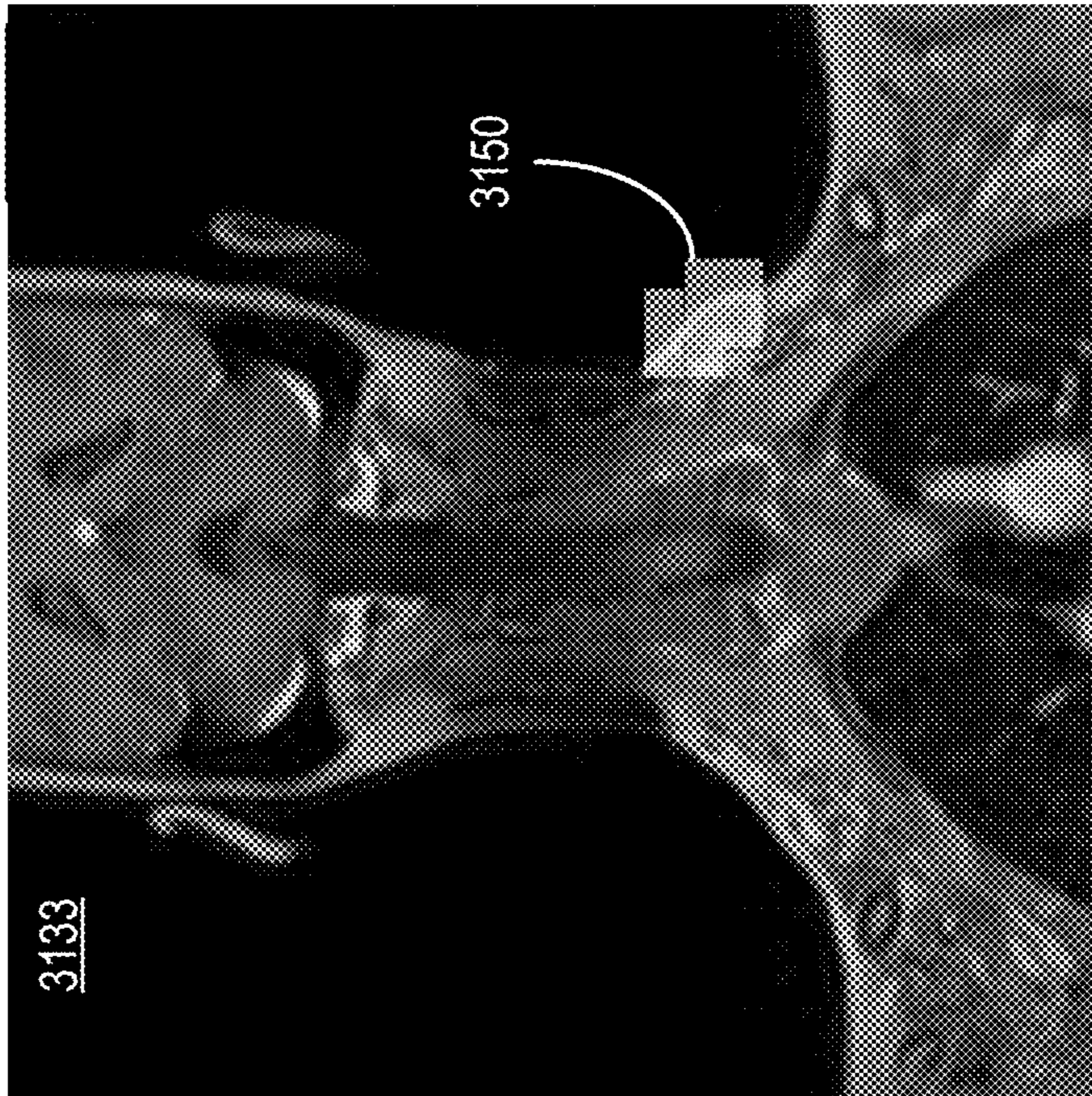

FIG. 12B

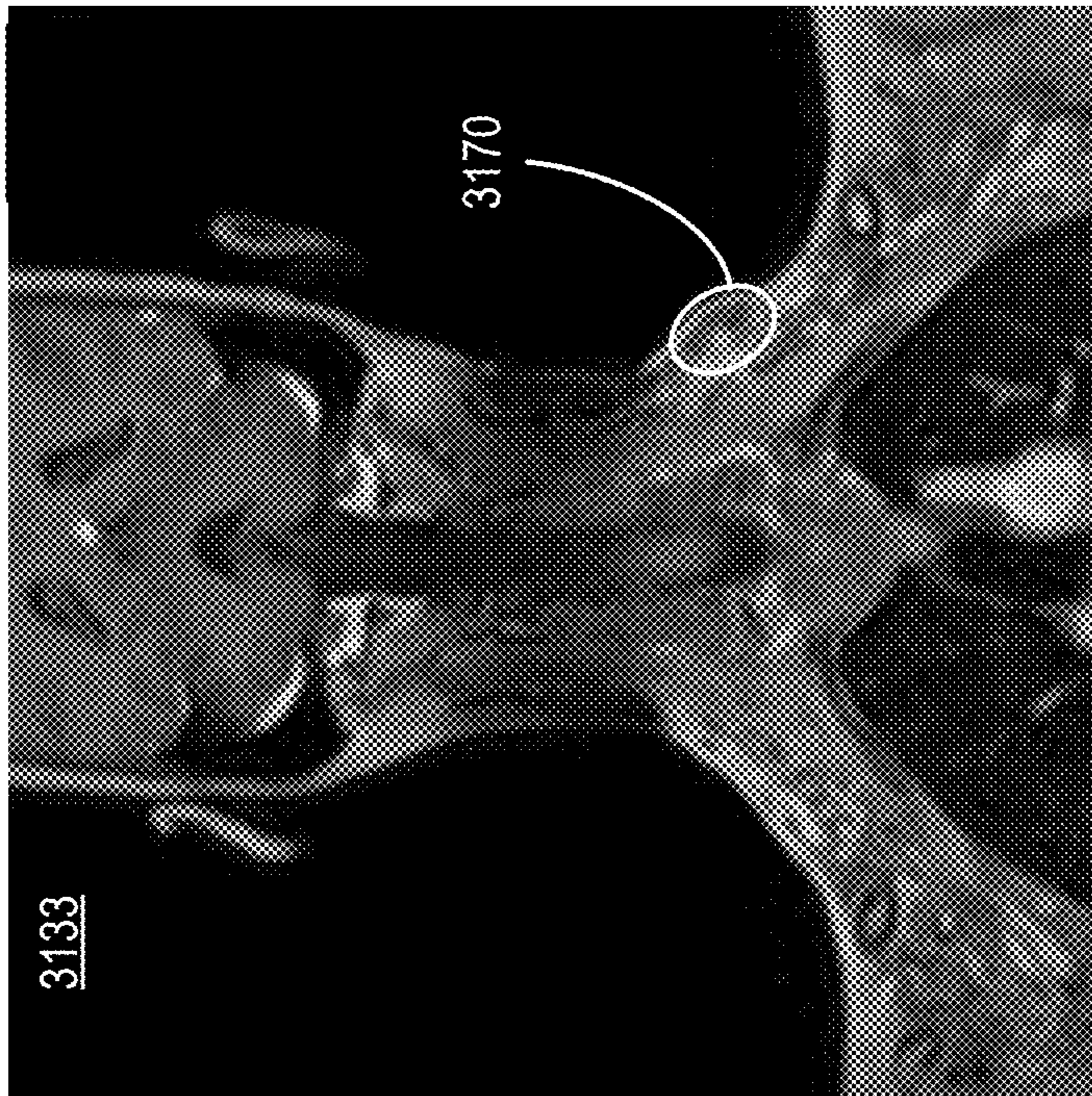

FIG. 12D

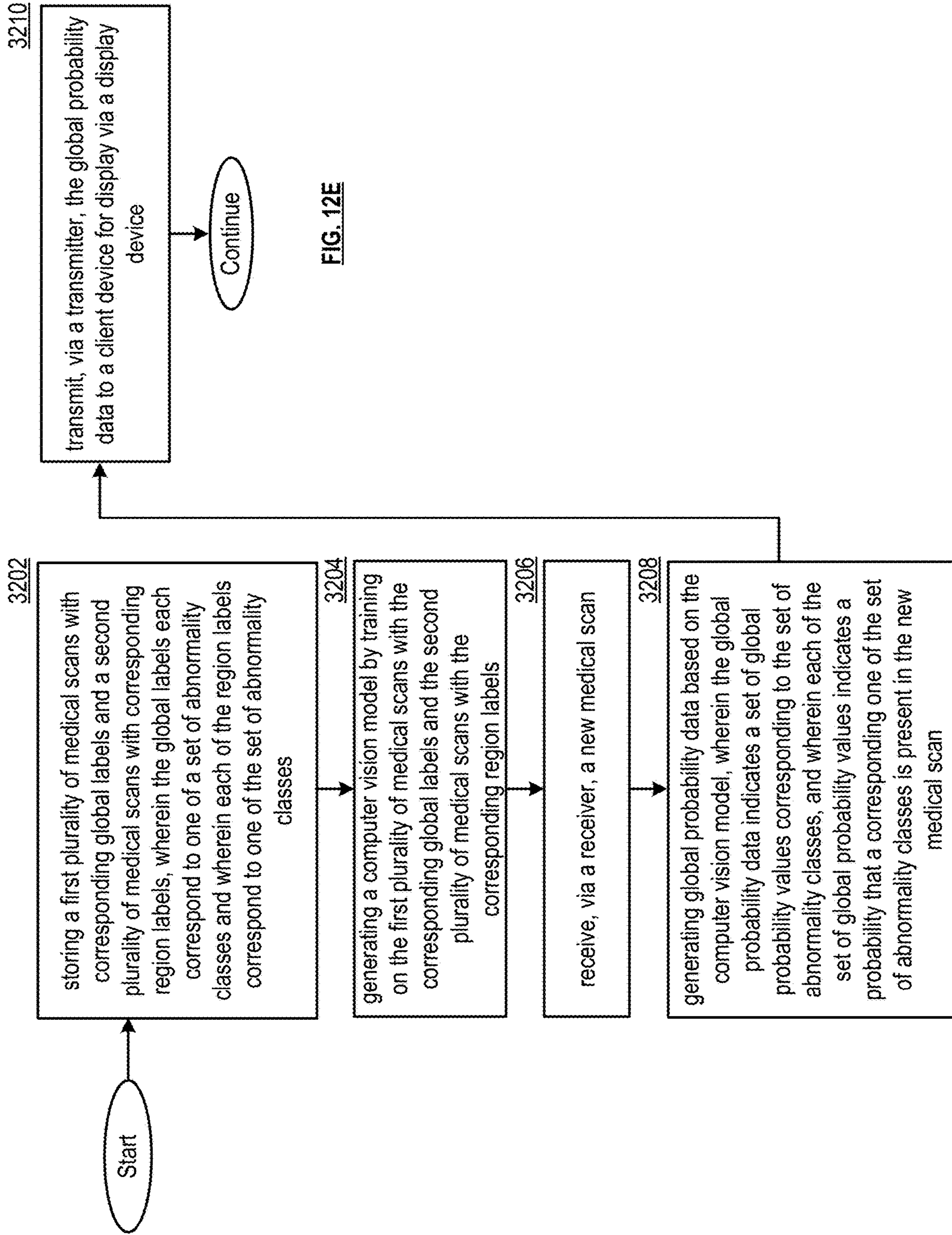

FIG. 12E

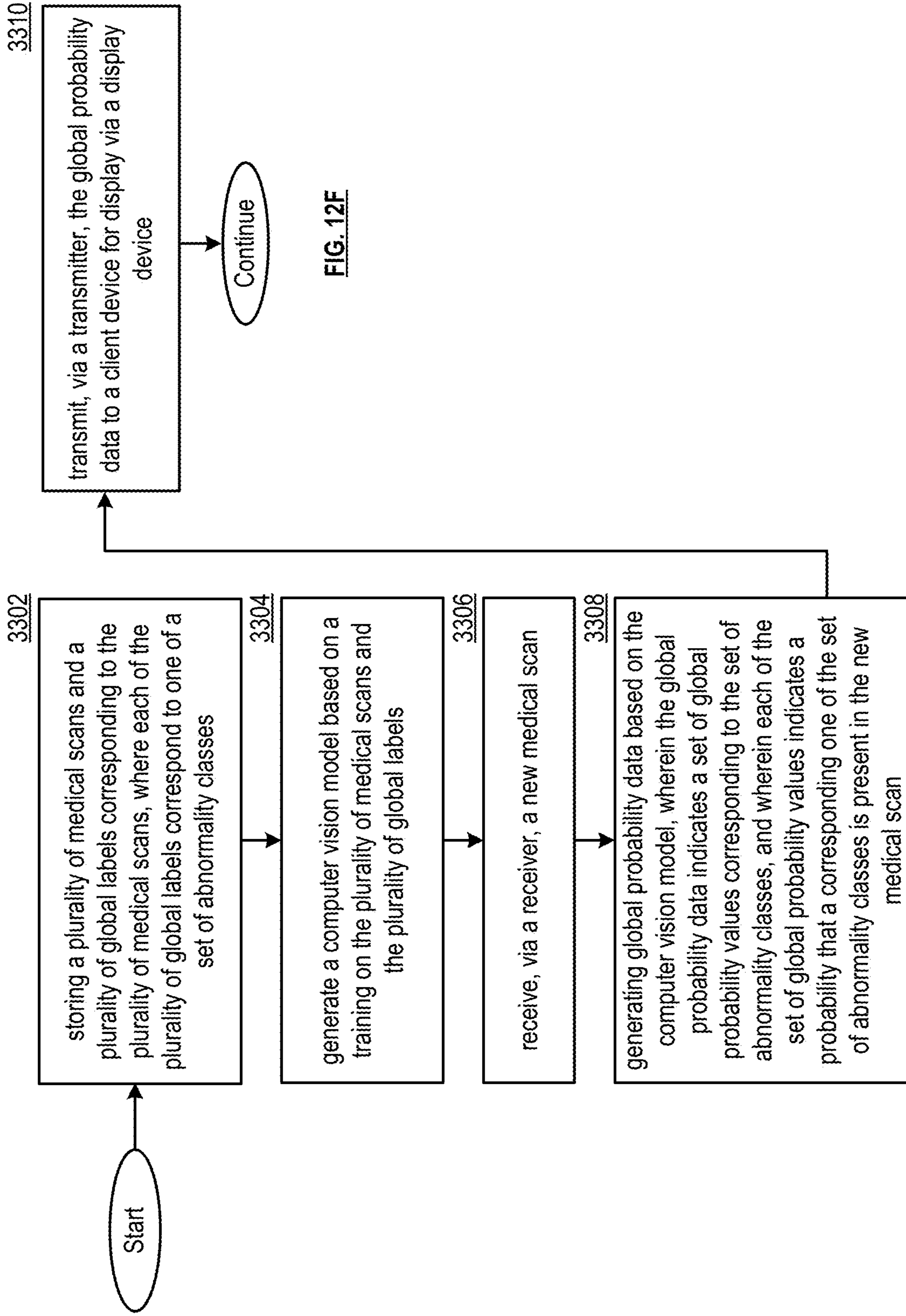
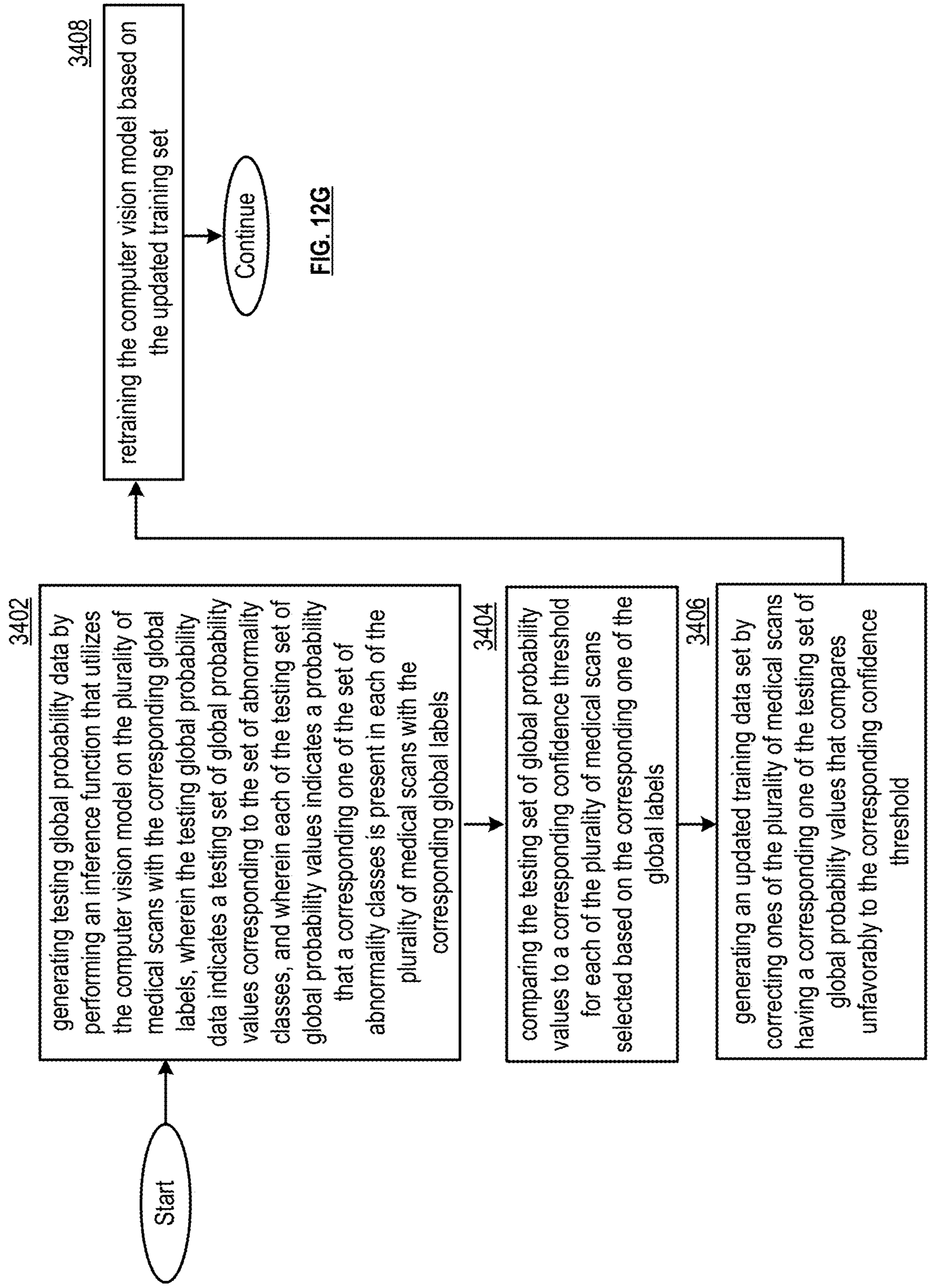

FIG. 12F



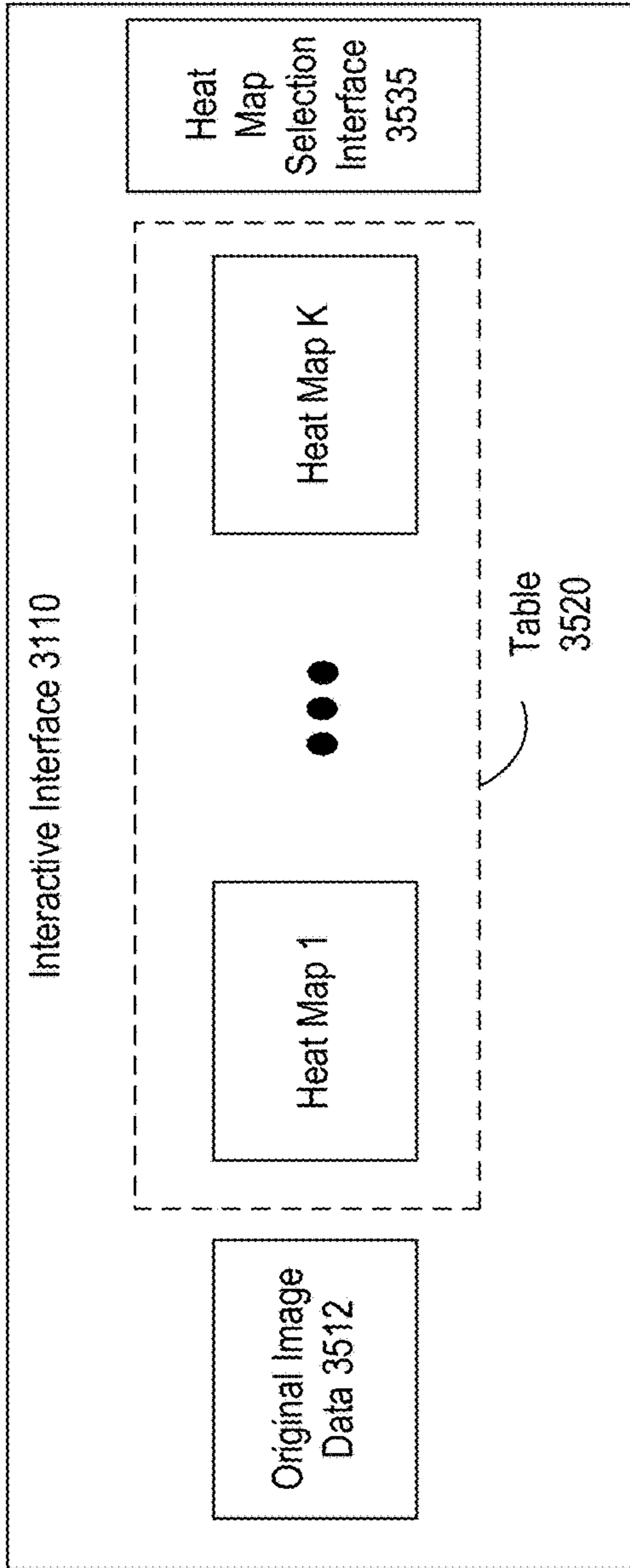

FIG. 13A

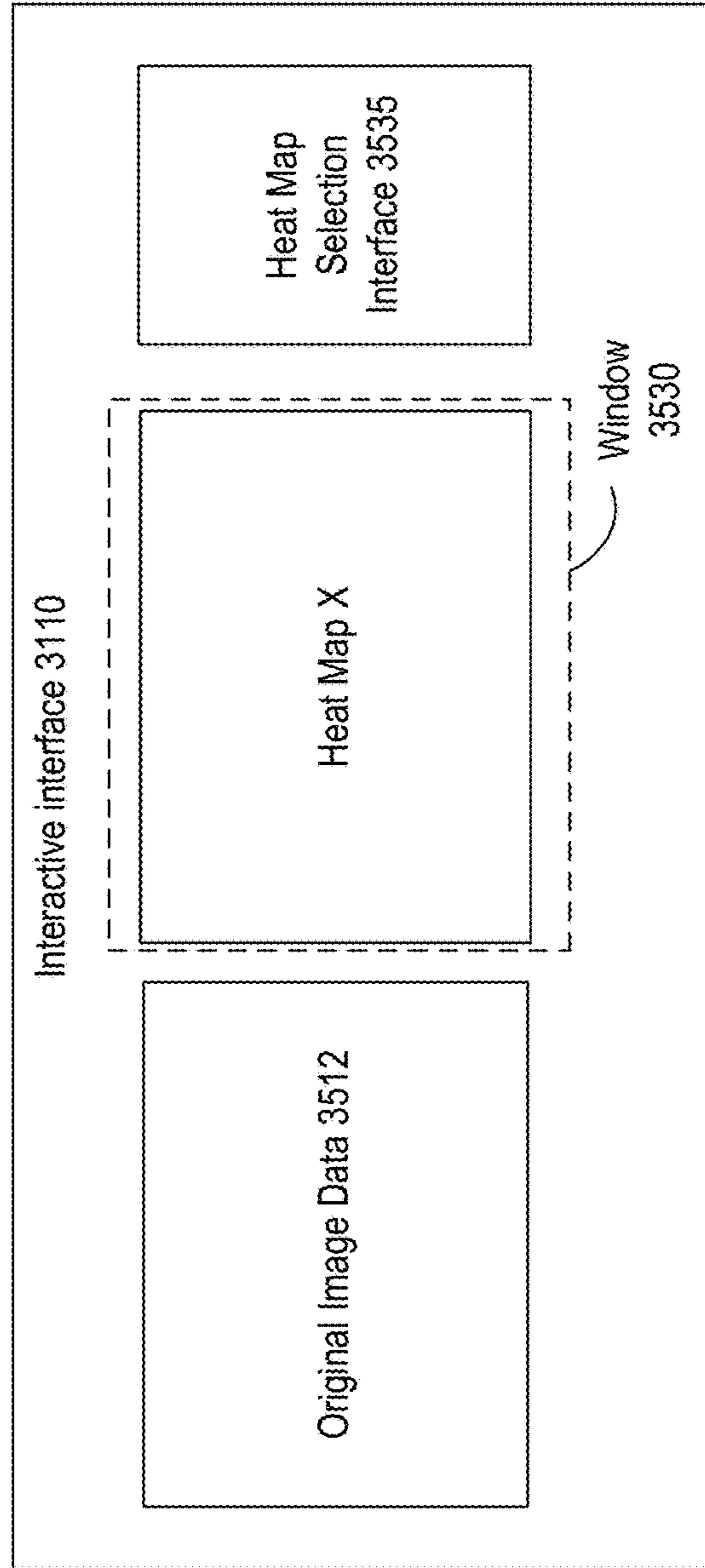

FIG. 13B

	AUC			DICE			
		$r_0 = 0$	$r_0 = 5$	$r_0 = 10$	$r_0 = 0$	$r_0 = 5$	$r_0 = 10$
	Atelectasis	0.7003	0.733	0.728	0.724	0.204	0.240
Cardiomegaly	0.8100	0.856	0.858	0.854	0.180	0.114	0.076
Effusion	0.7585	0.806	0.803	0.795	0.293	0.294	0.242
Infiltration	0.6614	0.673	0.675	0.668	0.325	0.312	0.286
Nodule	0.6687	0.718	0.724	0.727	0.202	0.238	0.196
Mass	0.6933	0.777	0.777	0.778	0.295	0.295	0.241
Pneumonia	0.6580	0.684	0.690	0.687	0.112	0.104	0.072
Pneumothorax	0.7993	0.805	0.791	0.763	0.039	0.023	0.028
Consolidation	0.7032	0.711	0.714	0.717	-	-	-
Edema	0.8052	0.806	0.804	0.801	-	-	-
Emphysema	0.8330	0.842	0.822	0.771	-	-	-
Fibrosis	0.7859	0.743	0.757	0.731	-	-	-
Pleural thickening	0.6835	0.724	0.715	0.712	-	-	-
Hernia	0.8717	0.775	0.764	0.824	-	-	-
A.V.G.	0.738	0.761	0.760	0.754	-	-	-

FIG. 14B

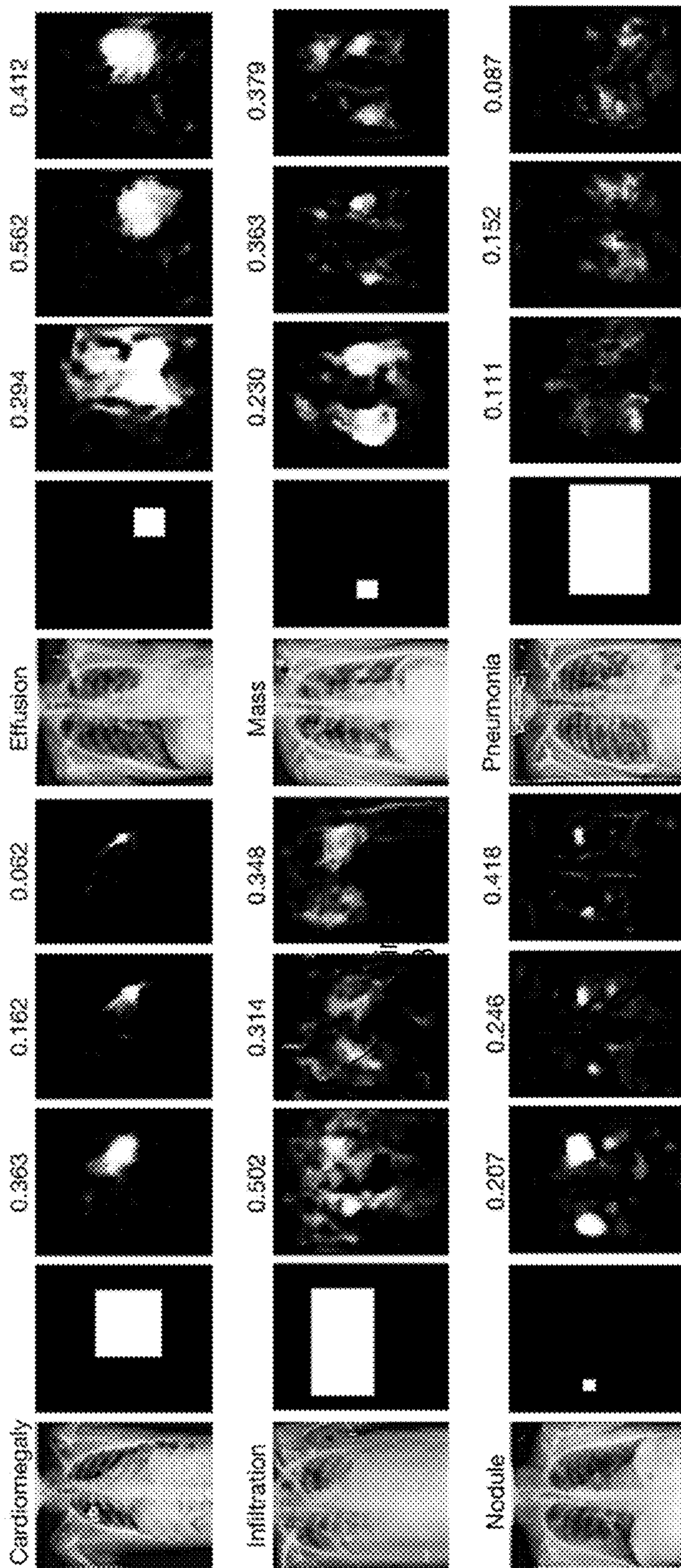

FIG. 14C

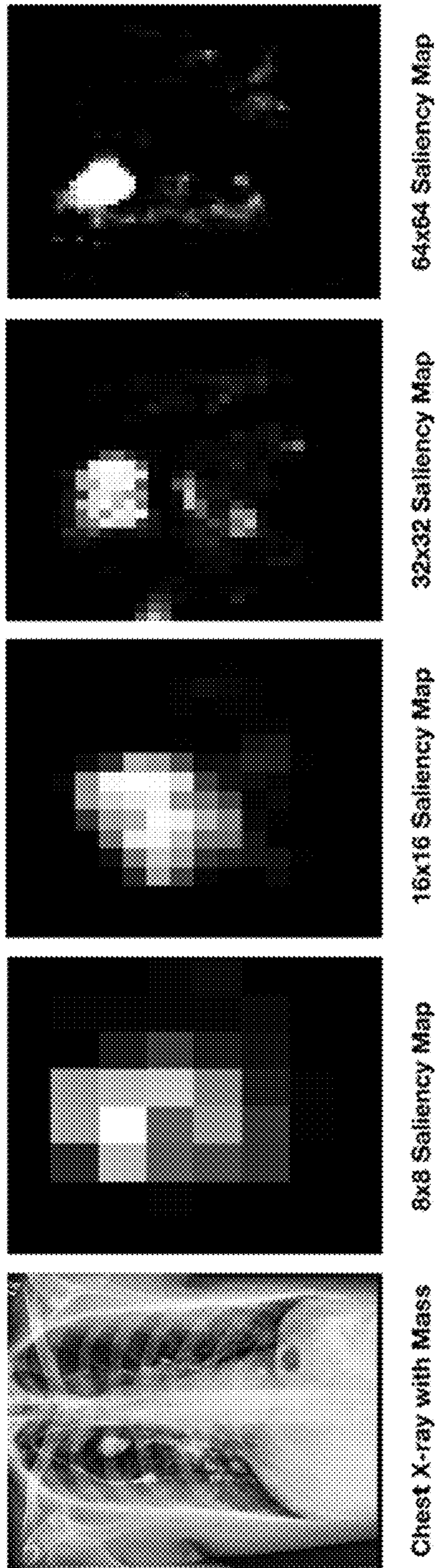

FIG. 14D

1

**MEDICAL SCAN VIEWING SYSTEM WITH
ENHANCED TRAINING AND METHODS
FOR USE THEREWITH**

CROSS REFERENCE TO RELATED
APPLICATIONS

The present U.S. Utility Patent Application claims priority pursuant to 35 U.S.C. § 120 as a continuation-in-part of U.S. Utility application Ser. No. 16/299,644, entitled “GLOBAL MULTI-LABEL GENERATING SYSTEM”, filed Mar. 12, 2019, which claims priority pursuant to 35 U.S.C. § 119(e) to U.S. Provisional Application No. 62/770,334, entitled “LESION TRACKING SYSTEM”, filed Nov. 21, 2018, both of which are hereby incorporated herein by reference in their entirety and made part of the present U.S. Utility Patent Application for all purposes.

STATEMENT REGARDING FEDERALLY
SPONSORED RESEARCH OR DEVELOPMENT

Not applicable.

BACKGROUND

Technical Field

This invention relates generally to medical imaging devices and knowledge-based systems used in conjunction with client/server network architectures.

BRIEF DESCRIPTION OF THE SEVERAL
VIEWS OF THE DRAWING(S)

FIG. 1 is a schematic block diagram of an embodiment; FIG. 2A is a schematic block diagram of a client device in accordance with various embodiments;

FIG. 2B is a schematic block diagram of one or more subsystems in accordance with various embodiments;

FIG. 3 is a schematic block diagram of a database storage system in accordance with various embodiments;

FIG. 4A is schematic block diagram of a medical scan entry in accordance with various embodiments;

FIG. 4B is a schematic block diagram of abnormality data in accordance with various embodiments;

FIG. 5 is a schematic block diagram of a medical scan analysis function entry in accordance with various embodiments;

FIGS. 6A-6B are schematic block diagram of a medical scan diagnosing system in accordance with various embodiments;

FIG. 7A is a flowchart representation of an inference step in accordance with various embodiments;

FIG. 7B is a flowchart representation of a detection step in accordance with various embodiments;

FIGS. 8A-8F are schematic block diagrams of a medical picture archive integration system in accordance with various embodiments;

FIG. 9 is a flowchart representation of a method for execution by a medical picture archive integration system in accordance with various embodiments;

FIG. 10A is a schematic block diagram of a de-identification system in accordance with various embodiments;

FIG. 10B is an illustration of an example of anonymizing patient identifiers in image data of a medical scan in accordance with various embodiments;

2

FIG. 11 presents a flowchart illustrating a method for execution by a de-identification system in accordance with various embodiments;

FIG. 12A is a schematic block diagram of a medical scan viewing system in accordance with various embodiments;

FIG. 12B-12D are pictorial diagrams of medical scans with region labels in accordance with various embodiments;

FIG. 12E presents a flowchart illustrating a method in accordance with various embodiments;

FIG. 12F presents a flowchart illustrating a method in accordance with various embodiments;

FIG. 12G presents a flowchart illustrating a method in accordance with various embodiments;

FIG. 13A is a pictorial diagram of an interactive user interface of a medical scan viewing system in accordance with various embodiments;

FIG. 13B is a pictorial diagram of an interactive user interface of a medical scan viewing system in accordance with various embodiments;

FIG. 14A illustrates an example embodiment of a model that is be utilized by the multi-label medical scan analysis system 3002; and

FIGS. 14B-14D illustrate example embodiment of the multi-label medical scan analysis system 3002.

DETAILED DESCRIPTION

The present U.S. Utility Patent Application is related to U.S. Utility application Ser. No. 15/627,644, entitled “MEDICAL SCAN ASSISTED REVIEW SYSTEM”, filed 20 Jun. 2017, which claims priority pursuant to 35 U.S.C. § 119(e) to U.S. Provisional Application No. 62/511,150, entitled “MEDICAL SCAN ASSISTED REVIEW SYSTEM AND METHODS”, filed 25 May 2017, and is also related to U.S. Utility application Ser. No. 16/353,935, entitled “LESION TRACKING SYSTEM”, filed on 14 Mar. 2019, which claims priority pursuant to 35 U.S.C. § 119(e) to U.S. Provisional Application No. 62/770,334, entitled “LESION TRACKING SYSTEM”, filed on 21 Nov. 2018, all of which are hereby incorporated herein by reference in their entirety and made part of the present U.S. Utility Patent Application for all purposes.

In accordance with various embodiments, a medical scan viewing system includes a network interface and a processing system that includes a processor. A memory device stores executable instructions that, when executed by the processing system, configure the processor to perform operations that can include: receiving, via the network interface, a first medical scan and a second medical scan from a medical picture archive system, the first medical scan associated with a first unique patient ID and a first scan date and the second medical scan associated with the first unique patient ID and a second scan date that is more recent than the first scan date, wherein the first medical scan includes a first plurality of image slices, and wherein the second medical scan includes a second plurality of image slices; identifying locations of a plurality of anatomical landmarks in the first medical scan; identifying corresponding locations of the plurality of anatomical landmarks in the second medical scan; co-registering the first medical scan with the second medical scan based on the locations of the plurality of anatomical landmarks in the first medical scan with the corresponding locations of the plurality of anatomical landmarks in the second medical scan; and presenting for display, via an interactive user interface, the first medical scan with the second medical scan, wherein the first medical

scan and the second medical scan are synchronously presented based on the co-registering.

In accordance with various embodiments, a medical scan viewing system includes a network interface and a processing system that includes a processor. A memory device stores executable instructions that, when executed by the processing system, configure the processor to perform operations that can include: receiving, via the network interface, a medical scan from a medical picture archive system; presenting the medical scan for display via an interactive user interface; receiving a command, via the interactive user interface, to automatically segment an abnormality or other feature in the medical scan; and automatically segmenting, in response to the command received via the interactive user interface, the medical scan to identify a region in the scan that contains the abnormality or other feature.

In accordance with various embodiments, a medical scan viewing system includes a network interface and a processing system that includes a processor. A memory device stores executable instructions that, when executed by the processing system, configure the processor to perform operations that can include: receiving, via the network interface, a medical scan from a medical picture archive system; presenting the medical scan for display via an interactive user interface; presenting a grid for display via the interactive user interface, wherein the grid is superimposed on the medical scan; and receiving selection data, via the interactive user interface, corresponding to a segmentation of the medical scan, wherein the segmentation identifies a region in the medical scan that contains an abnormality, and wherein the selection data identifies a plurality of elements of the grid that collectively identify the region in the medical scan that contains the abnormality.

In accordance with various embodiments, a medical scan viewing system includes a network interface and a processing system that includes a processor. A memory device stores executable instructions that, when executed by the processing system, configure the processor to perform operations that can include: receiving, via the network interface, a medical scan from a medical picture archive system, wherein the medical scan includes a plurality of image slices; identifying a span of image slices of the plurality image slices that span an abnormality; selecting a subset of the span of image slices; segmenting each individual image slice of the subset to identify a region in the individual image slice containing the abnormality, wherein the segmenting includes identifying a plurality of anchor points; and automatically segmenting intermediate image slices of the span of images between each successive pair of image slices in the subset by a blending operation that is based on the plurality of anchor points of the successive pair of images slices, wherein the segmenting of each of the intermediate slices identifies a region in each of the intermediate image slices containing the abnormality.

FIG. 1 presents a medical scan processing system 100, which can include one or more medical scan subsystems 101 that communicate bidirectionally with one or more client devices 120 via a wired and/or wireless network 150. The medical scan subsystems 101 can include a medical scan assisted review system 102, medical scan report labeling system 104, a medical scan annotator system 106, a medical scan diagnosing system 108, a medical scan interface feature evaluator system 110, a medical scan image analysis system 112, a medical scan natural language analysis system 114, and/or a medical scan comparison system 116. Some or all of the subsystems 101 can utilize the same processing

devices, memory devices, and/or network interfaces, for example, running on a same set of shared servers connected to network 150. Alternatively or in addition, some or all of the subsystems 101 be assigned their own processing devices, memory devices, and/or network interfaces, for example, running separately on different sets of servers connected to network 150. Some or all of the subsystems 101 can interact directly with each other, for example, where one subsystem's output is transmitted directly as input to another subsystem via network 150. Network 150 can include one or more wireless and/or wired communication systems; one or more non-public intranet systems and/or public internet systems; and/or one or more local area networks (LAN) and/or wide area networks (WAN).

The medical scan processing system 100 can further include a database storage system 140, which can include one or more servers, one or more memory devices of one or more subsystems 101, and/or one or more other memory devices connected to network 150. The database storage system 140 can store one or more shared databases and/or one or more files stored on one or more memory devices that include database entries as described herein. The shared databases and/or files can each be utilized by some or all of the subsystems of the medical scan processing system, allowing some or all of the subsystems and/or client devices to retrieve, edit, add, or delete entries to the one or more databases and/or files.

The one or more client devices 120 can each be associated with one or more users of one or more subsystems of the medical scan processing system. Some or all of the client devices can be associated with hospitals or other medical institutions and/or associated with medical professionals, employees, or other individual users for example, located at one or more of the medical institutions. Some of the client devices 120 can correspond to one or more administrators of one or more subsystems of the medical scan processing system, allowing administrators to manage, supervise, or override functions of one or more subsystems for which they are responsible.

Some or all of the subsystems 101 of the medical scan processing system 100 can include a server that presents a website for operation via a browser of client devices 120. Alternatively or in addition, each client device can store application data corresponding to some or all subsystems, for example, a subset of the subsystems that are relevant to the user in a memory of the client device, and a processor of the client device can display the interactive interface based on instructions in the interface data stored in memory. For example, the website presented by a subsystem can operate via the application. Some or all of the websites presented can correspond to multiple subsystems, for example, where the multiple subsystems share the server presenting the website. Furthermore, the network 150 can be configured for secure and/or authenticated communications between the medical scan subsystems 101, the client devices 120 and the database storage system 140 to protect the data stored in the database storage system and the data communicated between the medical scan subsystems 101, the client devices 120 and the database storage system 140 from unauthorized access.

The medical scan assisted review system 102 can be used to aid medical professionals or other users in diagnosing, triaging, classifying, ranking, and/or otherwise reviewing medical scans by presenting a medical scan for review by a user by transmitting medical scan data of a selected medical scan and/or interface feature data of selected interface features of to a client device 120 corresponding to a user of the medical scan assisted review system for display via a

5

display device of the client device. The medical scan assisted review system **102** can generate scan review data for a medical scan based on user input to the interactive interface displayed by the display device in response to prompts to provide the scan review data, for example, where the prompts correspond to one or more interface features.

The medical scan assisted review system **102** can be operable to receive, via a network, a medical scan for review. Abnormality annotation data can be generated by identifying one or more of abnormalities in the medical scan by utilizing a computer vision model that is trained on a plurality of training medical scans. The abnormality annotation data can include location data and classification data for each of the plurality of abnormalities and/or data that facilitates the visualization of the abnormalities in the scan image data. Report data including text describing each of the plurality of abnormalities is generated based on the abnormality data. The visualization and the report data, which can collectively be displayed annotation data, can be transmitted to a client device. A display device associated with the client device can display the visualization in conjunction with the medical scan via an interactive interface, and the display device can further display the report data via the interactive interface.

In various embodiments, longitudinal data, such as one or more additional scans of longitudinal data **433** of the medical scan or of similar scans, can be displayed in conjunction with the medical scan automatically, or in response to the user electing to view longitudinal data via user input. For example, the medical scan assisted review system can retrieve a previous scan or a future scan for the patient from a patient database or from the medical scan database automatically or in response to the user electing to view past patient data. One or more previous scans can be displayed in one or more corresponding windows adjacent to the current medical scan. For example, the user can select a past scan from the longitudinal data for display. Alternatively or in addition, the user can elect longitudinal parameters such as amount of time elapsed, scan type, electing to select the most recent and/or least recent scan, electing to select a future scan, electing to select a scan at a date closest to the scan, or other criteria, and the medical scan assisted review system can automatically select a previous scan that compares most favorably to the longitudinal parameters. The selected additional scan can be displayed in an adjacent window alongside the current medical scan. In some embodiments, multiple additional scans will be selected and can be displayed in multiple adjacent windows.

In various embodiments, a first window displaying an image slice **412** of the medical scan and an adjacent second window displaying an image slice of a selected additional scan will display image slices **412** determined to correspond with the currently displayed slice **412** of the medical scan. As described with respect to selecting a slice of a selected similar medical scan for display, this can be achieved based on selecting the image slice with a matching slice number, based on automatically determining the image slice that most closely matches the anatomical region corresponding to the currently displayed slice of the current scan, and/or based on determining the slice in the previous scan with the most similar view of the abnormality as the currently displayed slice. The user can use a single scroll bar or other single user input indication to jump to a different image slice, and the multiple windows can simultaneously display the same numbered image slice, or can scroll or jump by the same number of slices if different slice numbers are initially displayed. In some embodiments, three or more adjacent windows corresponding to the medical scan and two or more

6

additional scans are displayed, and can all be controlled with the single scroll bar in a similar fashion.

The medical scan assisted review system **102** can automatically detect previous states of the identified abnormalities based on the abnormality data, such as the abnormality location data. The detected previous states of the identified abnormality can be circled, highlighted, or otherwise indicated in their corresponding window. The medical scan assisted review system **102** can retrieve classification data for the previous state of the abnormality by retrieving abnormality annotation data **442** of the similar abnormality mapped to the previous scan from the medical scan database **342**. This data may not be assigned to the previous scan, and the medical scan assisted review system can automatically determine classification or other diagnosis data for the previous medical scan by utilizing the medical scan image analysis system as discussed. Alternatively or in addition, some or all of the abnormality classification data **445** or other diagnosis data **440** for the previous scan can be assigned values determined based on the abnormality classification data or other diagnosis data determined for the current scan. Such abnormality classification data **445** or other diagnosis data **440** determined for the previous scan can be mapped to the previous scan, and or mapped to the longitudinal data **433**, in the database and/or transmitted to a responsible entity via the network.

The medical assisted review system can automatically generate state change data such as a change in size, volume, malignancy, or other changes to various classifiers of the abnormality. This can be achieved by automatically comparing image data of one or more previous scans and the current scan and/or by comparing abnormality data of the previous scan to abnormality data of the current scan. In some embodiments, such metrics can be calculated by utilizing the medical scan similarity analysis function, for example, where the output of the medical scan similarity analysis function such as the similarity score indicates distance, error, or other measured discrepancy in one or more abnormality classifier categories **444** and/or abnormality pattern categories **446**. This calculated distance, error, or other measured discrepancy in each category can be used to quantify state change data, indicate a new classifier in one or more categories, to determine if a certain category has become more or less severe, or otherwise determine how the abnormality has changed over time. In various embodiments, this data can be displayed in one window, for example, where an increase in abnormality size is indicated by overlaying or highlighting an outline of the current abnormality over the corresponding image slice of the previous abnormality, or vice versa. In various embodiments where several past scans are available, such state change data can be determined over time, and statistical data showing growth rate changes over time or malignancy changes over time can be generated, for example, indicating if a growth rate is lessening or worsening over time. Image slices corresponding to multiple past scans can be displayed in sequence, for example, where a first scroll bar allows a user to scroll between image slice numbers, and a second scroll bar allows a user to scroll between the same image slice over time. In various embodiments the abnormality data, heat map data, or other interface features will be displayed in conjunction with the image slices of the past image data.

The medical scan report labeling system **104** can be used to automatically assign medical codes to medical scans based on user identified keywords, phrases, or other relevant medical condition terms of natural text data in a medical

scan report of the medical scan, identified by users of the medical scan report labeling system **104**. The medical scan report labeling system **104** can be operable to transmit a medical report that includes natural language text to a first client device for display. Identified medical condition term data can be received from the first client device in response. An alias mapping pair in a medical label alias database can be identified by determining that a medical condition term of the alias mapping pair compares favorably to the identified medical condition term data. A medical code that corresponds to the alias mapping pair and a medical scan that corresponds to the medical report can be transmitted to a second client device of an expert user for display, and accuracy data can be received from the second client device in response. The medical code is mapped to the first medical scan in a medical scan database when the accuracy data indicates that the medical code compares favorably to the medical scan.

The medical scan annotator system **106** can be used to gather annotations of medical scans based on review of the medical scan image data by users of the system such as radiologists or other medical professionals. Medical scans that require annotation, for example, that have been triaged from a hospital or other triaging entity, can be sent to multiple users selected by the medical scan annotator system **106**, and the annotations received from the multiple medical professionals can be processed automatically by a processing system of the medical scan annotator system, allowing the medical scan annotator system to automatically determine a consensus annotation of each medical scan. Furthermore, the users can be automatically scored by the medical scan annotator system based on how closely their annotation matches to the consensus annotation or some other truth annotation, for example, corresponding to annotations of the medical scan assigned a truth flag. Users can be assigned automatically to annotate subsequent incoming medical scans based on their overall scores and/or based on categorized scores that correspond to an identified category of the incoming medical scan.

The medical scan annotator system **106** can be operable to select a medical scan for transmission via a network to a first client device and a second client device for display via an interactive interface, and annotation data can be received from the first client device and the second client device in response. Annotation similarity data can be generated by comparing the first annotation data to the second annotation data, and consensus annotation data can be generated based on the first annotation data and the second annotation data in response to the annotation similarity data indicating that the difference between the first annotation data and the second annotation data compares favorably to an annotation discrepancy threshold. The consensus annotation data can be mapped to the medical scan in a medical scan database.

A medical scan diagnosing system **108** can be used by hospitals, medical professionals, or other medical entities to automatically produce inference data for given medical scans by utilizing computer vision techniques and/or natural language processing techniques. This automatically generated inference data can be used to generate and/or update diagnosis data or other corresponding data of corresponding medical scan entries in a medical scan database. The medical scan diagnosing system can utilize a medical scan database, user database, and/or a medical scan analysis function database by communicating with the database storage system **140** via the network **150**, and/or can utilize another medical scan database, user database, and/or function database stored in local memory.

The medical scan diagnosing system **108** can be operable to receive a medical scan. Diagnosis data of the medical scan can be generated by performing a medical scan inference function on the medical scan. The first medical scan can be transmitted to a first client device associated with a user of the medical scan diagnosing system in response to the diagnosis data indicating that the medical scan corresponds to a non-normal diagnosis. The medical scan can be displayed to the user via an interactive interface displayed by a display device corresponding to the first client device. Review data can be received from the first client device, where the review data is generated by the first client device in response to a prompt via the interactive interface. Updated diagnosis data can be generated based on the review data. The updated diagnosis data can be transmitted to a second client device associated with a requesting entity.

A medical scan interface feature evaluating system **110** can be used evaluate proposed interface features or currently used interface features of an interactive interface to present medical scans for review by medical professionals or other users of one or more subsystems **101**. The medical scan interface feature evaluator system **110** can be operable to generate an ordered image-to-prompt mapping by selecting a set of user interface features to be displayed with each of an ordered set of medical scans. The set of medical scans and the ordered image-to-prompt mapping can be transmitted to a set of client devices. A set of responses can be generated by each client device in response to sequentially displaying each of the set of medical scans in conjunction with a mapped user interface feature indicated in the ordered image-to-prompt mapping via a user interface. Response score data can be generated by comparing each response to truth annotation data of the corresponding medical scan. Interface feature score data corresponding to each user interface feature can be generated based on aggregating the response score data, and is used to generate a ranking of the set of user interface features.

A medical scan image analysis system **112** can be used to generate and/or perform one or more medical scan image analysis functions by utilizing a computer vision-based learning algorithm **1350** on a training set of medical scans with known annotation data, diagnosis data, labeling and/or medical code data, report data, patient history data, patient risk factor data, and/or other metadata associated with medical scans. These medical scan image analysis functions can be used to generate inference data for new medical scans that are triaged or otherwise require inferred annotation data, diagnosis data, labeling and/or medical code data, and/or report data. For example, some medical scan image analysis functions can correspond to medical scan inference functions of the medical scan diagnosing system or other medical scan analysis functions of a medical scan analysis function database. The medical scan image analysis functions can be used to determine whether or not a medical scan is normal, to detect the location of an abnormality in one or more slices of a medical scan, and/or to characterize a detected abnormality. The medical scan image analysis system can be used to generate and/or perform computer vision based medical scan image analysis functions utilized by other subsystems of the medical scan processing system as described herein, aiding medical professionals to diagnose patients and/or to generate further data and models to characterize medical scans. The medical scan image analysis system can include a processing system that includes a processor and a memory that stores executable instructions that, when executed by the processing system, facilitate performance of operations.

The medical scan image analysis system **112** can be operable to receive a plurality of medical scans that represent a three-dimensional anatomical region and include a plurality of cross-sectional image slices. A plurality of three-dimensional subregions corresponding to each of the plurality of medical scans can be generated by selecting a proper subset of the plurality of cross-sectional image slices from each medical scan, and by further selecting a two-dimensional subregion from each proper subset of cross-sectional image slices. A learning algorithm can be performed on the plurality of three-dimensional subregions to generate a neural network. Inference data corresponding to a new medical scan received via the network can be generated by performing an inference algorithm on the new medical scan by utilizing the neural network. An inferred abnormality can be identified in the new medical scan based on the inference data.

The medical scan natural language analysis system **114** can determine a training set of medical scans with medical codes determined to be truth data. Corresponding medical reports and/or other natural language text data associated with a medical scan can be utilized to train a medical scan natural language analysis function by generating a medical report natural language model. The medical scan natural language analysis function can be utilized to generate inference data for incoming medical reports for other medical scans to automatically determine corresponding medical codes, which can be mapped to corresponding medical scans. Medical codes assigned to medical scans by utilizing the medical report natural language model can be utilized by other subsystems, for example, to train other medical scan analysis functions, to be used as truth data to verify annotations provided via other subsystems, to aid in diagnosis, or otherwise be used by other subsystems as described herein.

A medical scan comparison system **116** can be utilized by one or more subsystems to identify and/or display similar medical scans, for example, to perform or determine function parameters for a medical scan similarity analysis function, to generate or retrieve similar scan data, or otherwise compare medical scan data. The medical scan comparison system **116** can also utilize some or all features of other subsystems as described herein. The medical scan comparison system **116** can be operable to receive a medical scan via a network and can generate similar scan data. The similar scan data can include a subset of medical scans from a medical scan database and can be generated by performing an abnormality similarity function, such as medical scan similarity analysis function, to determine that a set of abnormalities included in the subset of medical scans compare favorably to an abnormality identified in the medical scan. At least one cross-sectional image can be selected from each medical scan of the subset of medical scans for display on a display device associated with a user of the medical scan comparison system in conjunction with the medical scan.

FIG. 2A presents an embodiment of client device **120**. Each client device **120** can include one or more client processing devices **230**, one or more client memory devices **240**, one or more client input devices **250**, one or more client network interfaces **260** operable to more support one or more communication links via the network **150** indirectly and/or directly, and/or one or more client display devices **270**, connected via bus **280**. Client applications **202**, **204**, **206**, **208**, **210**, **212**, **214**, and/or **216** correspond to subsystems **102**, **104**, **106**, **108**, **110**, **112**, **114**, and/or **116** of the medical scan processing system respectfully. Each client device **120** can receive the application data from the corre-

sponding subsystem via network **150** by utilizing network interface **260**, for storage in the one or more memory devices **240**. In various embodiments, some or all client devices **120** can include a computing device associated with a radiologist, medical entity, or other user of one or more subsystems as described herein.

The one or more processing devices **230** can display interactive interface **275** on the one or more client display devices **270** in accordance with one or more of the client applications **202**, **204**, **206**, **208**, **210**, **212**, **214**, and/or **216**, for example, where a different interactive interface **275** is displayed for some or all of the client applications in accordance with the website presented by the corresponding subsystem **102**, **104**, **106**, **108**, **110**, **112**, **114** and/or **116**. The user can provide input in response to menu data or other prompts presented by the interactive interface via the one or more client input devices **250**, which can include a microphone, mouse, keyboard, touchscreen of display device **270** itself or other touchscreen, and/or other device allowing the user to interact with the interactive interface. The one or more processing devices **230** can process the input data and/or send raw or processed input data to the corresponding subsystem, and/or can receive and/or generate new data in response for presentation via the interactive interface **275** accordingly, by utilizing network interface **260** to communicate bidirectionally with one or more subsystems and/or databases of the medical scan processing system via network **150**.

FIG. 2B presents an embodiment of a subsystem **101**, which can be utilized in conjunction with subsystem **102**, **104**, **106**, **108**, **110**, **112**, **114** and/or **116**. Each subsystem **101** can include one or more subsystem processing devices **235**, one or more subsystem memory devices **245**, and/or one or more subsystem network interfaces **265**, connected via bus **285**. The subsystem memory devices **245** can store executable instructions that, when executed by the one or more subsystem processing devices **235**, facilitate performance of operations by the subsystem **101**, as described for each subsystem herein.

FIG. 3 presents an embodiment of the database storage system **140**. Database storage system **140** can include at least one database processing device **330**, at least one database memory device **340**, and at least one database network interface **360**, operable to more support one or more communication links via the network **150** indirectly and/or directly, all connected via bus **380**. The database storage system **140** can store one or more databases the at least one memory **340**, which can include a medical scan database **342** that includes a plurality medical scan entries **352**, a user database **344** that includes a plurality of user profile entries **354**, a medical scan analysis function database **346** that includes a plurality of medical scan analysis function entries **356**, an interface feature database **348** can include a plurality of interface feature entries **358**, and/or other databases that store data generated and/or utilized by the subsystems **101**. Some or all of the databases **342**, **344**, **346** and/or **348** can consist of multiple databases, can be stored relationally or non-relationally, and can include different types of entries and different mappings than those described herein. A database entry can include an entry in a relational table or entry in a non-relational structure. Some or all of the data attributes of an entry **352**, **354**, **356**, and/or **358** can refer to data included in the entry itself or that is otherwise mapped to an identifier included in the entry and can be retrieved from, added to, modified, or deleted from the database storage system **140** based on a given identifier of the entry. Some or all of the databases **342**, **344**, **346**, and/or **348** can instead be

11

stored locally by a corresponding subsystem, for example, if they are utilized by only one subsystem.

The processing device **330** can facilitate read/write requests received from subsystems and/or client devices via the network **150** based on read/write permissions for each database stored in the at least one memory device **340**. Different subsystems can be assigned different read/write permissions for each database based on the functions of the subsystem, and different client devices **120** can be assigned different read/write permissions for each database. One or more client devices **120** can correspond to one or more administrators of one or more of the databases stored by the database storage system, and database administrator devices can manage one or more assigned databases, supervise assess and/or efficiency, edit permissions, or otherwise oversee database processes based on input to the client device via interactive interface **275**.

FIG. **4A** presents an embodiment of a medical scan entry **352**, stored in medical scan database **342**, included in metadata of a medical scan, and/or otherwise associated with a medical scan. A medical scan can include imaging data corresponding to a CT scan, x-ray, MRI, PET scan, Ultrasound, EEG, mammogram, or other type of radiological scan or medical scan taken of an anatomical region of a human body, animal, organism, or object and further can include metadata corresponding to the imaging data. Some or all of the medical scan entries can be formatted in accordance with a Digital Imaging and Communications in Medicine (DICOM) format or other standardized image format, and some or more of the fields of the medical scan entry **352** can be included in a DICOM header or other standardized header of the medical scan. Medical scans can be awaiting review or can have already been reviewed by one or more users or automatic processes and can include tentative diagnosis data automatically generated by a subsystem, generated based on user input, and/or generated from another source. Some medical scans can include final, known diagnosis data generated by a subsystem and/or generated based on user input, and/or generated from another source, and can included in training sets used to train processes used by one or more subsystems such as the medical scan image analysis system **112** and/or the medical scan natural language analysis system **114**.

Some medical scans can include one or more abnormalities, which can be identified by a user or can be identified automatically. Abnormalities can include nodules, for example malignant nodules identified in a chest CT scan. Abnormalities can also include and/or be characterized by one or more abnormality pattern categories such as such as cardiomegaly, consolidation, effusion, emphysema, and/or fracture, for example identified in a chest x-ray. Abnormalities can also include any other unknown, malignant or benign feature of a medical scan identified as not normal. Some scans can contain zero abnormalities, and can be identified as normal scans. Some scans identified as normal scans can include identified abnormalities that are classified as benign, and include zero abnormalities classified as either unknown or malignant. Scans identified as normal scans may include abnormalities that were not detected by one or more subsystems and/or by an originating entity. Thus, some scans may be improperly identified as normal. Similarly, scans identified to include at least one abnormality may include at least one abnormality that was improperly detected as an abnormality by one or more subsystems and/or by an originating entity. Thus, some scans may be improperly identified as containing abnormalities.

12

Each medical scan entry **352** can be identified by its own medical scan identifier **353**, and can include or otherwise map to medical scan image data **410**, and metadata such as scan classifier data **420**, patient history data **430**, diagnosis data **440**, annotation author data **450**, confidence score data **460**, display parameter data **470**, similar scan data **480**, training set data **490**, and/or other data relating to the medical scan. Some or all of the data included in a medical scan entry **352** can be used to aid a user in generating or editing diagnosis data **440**, for example, in conjunction with the medical scan assisted review system **102**, the medical scan report labeling system **104**, and/or the medical scan annotator system **106**. Some or all of the data included in a medical scan entry **352** can be used to allow one or more subsystems **101**, such as automated portions of the medical scan report labeling system **104** and/or the medical scan diagnosing system **108**, to automatically generate and/or edit diagnosis data **440** or other data the medical scan. Some or all of the data included in a medical scan entry **352** can be used to train some or all medical scan analysis functions of the medical scan analysis function database **346** such as one or more medical scan image analysis functions, one or more medical scan natural language analysis functions, one or more medical scan similarity analysis functions, one or more medical report generator functions, and/or one or more medical report analysis functions, for example, in conjunction with the medical scan image analysis system **112**, the medical scan natural language analysis system **114**, and/or the medical scan comparison system **116**.

The medical scan entries **352** and the associated data as described herein can also refer to data associated with a medical scan that is not stored by the medical scan database, for example, that is uploaded by a client device for direct transmission to a subsystem, data generated by a subsystem and used as input to another subsystem or transmitted directly to a client device, data stored by a Picture Archive and Communication System (PACS) communicating with the medical scan processing system **100**, or other data associated with a medical scan that is received and or generated without being stored in the medical scan database **342**. For example, some or all of the structure and data attributes described with respect to a medical scan entry **352** can also correspond to structure and/or data attribute of data objects or other data generated by and/or transmitted between subsystems and/or client devices that correspond to a medical scan. Herein, any of the data attributes described with respect to a medical scan entry **352** can also correspond to data extracted from a data object generated by a subsystem or client device or data otherwise received from a subsystem, client device, or other source via network **150** that corresponds to a medical scan.

The medical scan image data **410** can include one or more images corresponding to a medical scan. The medical scan image data **410** can include one or more image slices **412**, for example, corresponding to a single x-ray image, a plurality of cross-sectional, tomographic images of a scan such as a CT scan, or any plurality of images taken from the same or different point at the same or different angles. The medical scan image data **410** can also indicate an ordering of the one or more image slices **412**. Herein, a “medical scan” can refer a full scan of any type represented by medical scan image data **410**. Herein, an “image slice” can refer to one of a plurality of cross-sectional images of the medical scan image data **410**, one of a plurality of images taken from different angles of the medical scan image data **410**, and/or the single image of the medical scan image data **410** that includes only one image. Furthermore “plurality of

image slices” can refer to all of the images of the associated medical scan, and refers to only a single image if the medical scan image data **410** includes only one image. Each image slice **412** can include a plurality of pixel values **414** mapped to each pixel of the image slice. Each pixel value can correspond to a density value, such as a Hounsfield value or other measure of density. Pixel values can also correspond to a grayscale value, a RGB (Red-Green-Blue) or other color value, or other data stored by each pixel of an image slice **412**.

Scan classifier data **420** can indicate classifying data of the medical scan. Scan classifier data can include scan type data **421**, for example, indicating the modality of the scan. The scan classifier data can indicate that the scan is a CT scan, x-ray, Mill, PET scan, Ultrasound, EEG, mammogram, or other type of scan. Scan classifier data **420** can also include anatomical region data **422**, indicating for example, the scan is a scan of the chest, head, right knee, or other anatomical region. Scan classifier data can also include originating entity data **423**, indicating the hospital where the scan was taken and/or a user that uploaded the scan to the system. If the originating entity data corresponds to a user of one or more subsystems **101**, the originating entity data can include a corresponding user profile identifier and/or include other data from the user profile entry **354** of the user. Scan classifier data **420** can include geographic region data **424**, indicating a city, state, and/or country from which the scan originated, for example, based on the user data retrieved from the user database **344** based on the originating entity. Scan classifier data can also include machine data **425**, which can include machine identifier data, machine model data, machine calibration data, and/or contrast agent data, for example based on imaging machine data retrieved from the user database **344** based on the originating entity data **423**. The scan classifier data **420** can include scan date data **426** indicating when the scan was taken. The scan classifier data **420** can include scan priority data **427**, which can indicate a priority score, ranking, number in a queue, or other priority data with regard to triaging and/or review. A priority score, ranking, or queue number of the scan priority data **427** can be generated by automatically by a subsystem based on the scan priority data **427**, based on a severity of patient symptoms or other indicators in the risk factor data **432**, based on a priority corresponding to the originating entity, based on previously generated diagnosis data **440** for the scan, and/or can be assigned by the originating entity and/or a user of the system.

The scan classifier data **420** can include other classifying data not pictured in FIG. **4A**. For example, a set of scans can include medical scan image data **410** corresponding to different imaging planes. The scan classifier data can further include imaging plane data indicating one or more imaging planes corresponding to the image data. For example, the imaging plane data can indicate the scan corresponds to the axial plane, sagittal plane, or coronal plane. A single medical scan entry **352** can include medical scan image data **410** corresponding multiple planes, and each of these planes can be tagged appropriately in the image data. In other embodiments, medical scan image data **410** corresponding to each plane can be stored as separate medical scan entries **352**, for example, with a common identifier indicating these entries belong to the same set of scans.

Alternatively or in addition, the scan classifier data **420** can include sequencing data. For example, a set of scans can include medical scan image data **410** corresponding to different sequences. The scan classifier data can further include sequencing data indicating one or more of a plurality

of sequences of the image data corresponds to, for example, indicating whether an MRI scan corresponds to a T2 sequence, a T1 sequence, a T1 sequence with contrast, a diffusion sequence, a FLAIR sequence, or other MRI sequence. A single medical scan entry **352** can include medical scan image data **410** corresponding to multiple sequences, and each of these sequences can be tagged appropriately in the entry. In other embodiments, medical scan image data **410** corresponding to each sequence can be stored as separate medical scan entries **352**, for example, with a common identifier indicating these entries belong to the same set of scans.

Alternatively or in addition, the scan classifier data **420** can include an image quality score. This score can be determined automatically by one or more subsystems **101**, and/or can be manually assigned the medical scan. The image quality score can be based on a resolution of the image data **410**, where higher resolution image data is assigned a more favorable image quality score than lower resolution image data. The image quality score can be based on whether the image data **410** corresponds to digitized image data received directly from the corresponding imaging machine, or corresponds to a hard copy of the image data that was later scanned in. In some embodiments, the image quality score can be based on a detected corruption, and/or detected external factor that determined to negatively affect the quality of the image data during the capturing of the medical scan and/or subsequent to the capturing of the medical scan. In some embodiments, the image quality score can be based on detected noise in the image data, where a medical scan with a higher level of detected noise can receive a less favorable image quality score than a medical scan with a lower level of detected noise. Medical scans with this determined corruption or external factor can receive a less favorable image quality score than medical scans with no detected corruption or external factor.

In some embodiments, the image quality score can be based on include machine data **425**. In some embodiments, one or more subsystems can utilize the image quality score to flag medical scans with image quality scores that fall below an image quality threshold. The image quality threshold can be the same or different for different subsystems, medical scan modalities, and/or anatomical regions. For example, the medical scan image analysis system can automatically filter training sets based on selecting only medical scans with image quality scores that compare favorably to the image quality threshold. As another example, one or more subsystems can flag a particular imaging machine and/or hospital or other medical entity that have produced at least a threshold number and/or percentage of medical scan with image quality scores that compare unfavorably to the image quality threshold. As another example, a de-noising algorithm can be automatically utilized to clean the image data when the image quality score compares unfavorably to the image quality threshold. As another example, the medical scan image analysis system can select a particular medical image analysis function from a set of medical image analysis functions to utilize on a medical scan to generate inference data for the medical scan. Each of this set of medical image analysis function can be trained on different levels of image quality, and the selected image analysis function can be selected based on the determined image quality score falling within a range of image quality scores the image analysis function was trained on and/or is otherwise suitable for.

The patient history data **430** can include patient identifier data **431** which can include basic patient information such as

name or an identifier that may be anonymized to protect the confidentiality of the patient, age, and/or gender. The patient identifier data **431** can also map to a patient entry in a separate patient database stored by the database storage system, or stored elsewhere. The patient history data can include patient risk factor data **432** which can include previous medical history, family medical history, smoking and/or drug habits, pack years corresponding to tobacco use, environmental exposures, patient symptoms, etc. The patient history data **430** can also include longitudinal data **433**, which can identify one or more additional medical scans corresponding to the patient, for example, retrieved based on patient identifier data **431** or otherwise mapped to the patient identifier data **431**. Some or all additional medical scans can be included in the medical scan database, and can be identified based on their corresponding identifiers medical scan identifiers **353**. Some or all additional medical scans can be received from a different source and can otherwise be identified. Alternatively or in addition, the longitudinal data can simply include some or all relevant scan entry data of a medical scan entry **352** corresponding to the one or more additional medical scans. The additional medical scans can be the same type of scan or different types of scans. Some or all of the additional scans may correspond to past medical scans, and/or some or all of the additional scans may correspond to future medical scans. The longitudinal data **433** can also include data received and/or determined at a date after the scan such as final biopsy data, or some or all of the diagnosis data **440**. The patient history data can also include a longitudinal quality score **434**, which can be calculated automatically by a subsystem, for example, based on the number of additional medical scans, based on how many of the additional scans in the file were taken before and/or after the scan based on the scan date data **426** of the medical scan and the additional medical scans, based on a date range corresponding to the earliest scan and corresponding to the latest scan, based on the scan types data **421** these scans, and/or based on whether or not a biopsy or other final data is included. As used herein, a “high” longitudinal quality score refers to a scan having more favorable longitudinal data than that with a “low” longitudinal quality score.

Diagnosis data **440** can include data that indicates an automated diagnosis, a tentative diagnosis, and/or data that can otherwise be used to support medical diagnosis, triage, medical evaluation and/or other review by a medical professional or other user. The diagnosis data **440** of a medical scan can include a binary abnormality identifier **441** indicating whether the scan is normal or includes at least one abnormality. In some embodiments, the binary abnormality identifier **441** can be determined by comparing some or all of confidence score data **460** to a threshold, can be determined by comparing a probability value to a threshold, and/or can be determined by comparing another continuous or discrete value indicating a calculated likelihood that the scan contains one or more abnormalities to a threshold. In some embodiments, non-binary values, such as one or more continuous or discrete values indicating a likelihood that the scan contains one or more abnormalities, can be included in diagnosis data **440** in addition to, or instead of, binary abnormality identifier **441**. One or abnormalities can be identified by the diagnosis data **440**, and each identified abnormality can include its own set of abnormality annotation data **442**. Alternatively, some or all of the diagnosis data **440** can indicate and/or describe multiple abnormalities, and thus will not be presented for each abnormality in the abnormality annotation data **442**. For example, the report

data **449** of the diagnosis data **440** can describe all identified abnormalities, and thus a single report can be included in the diagnosis.

FIG. **4B** presents an embodiment of the abnormality annotation data **442**. The abnormality annotation data **442** for each abnormality can include abnormality location data **443**, which can include an anatomical location and/or a location specific to pixels, image slices, coordinates or other location information identifying regions of the medical scan itself. The abnormality annotation data **442** can include abnormality classification data **445** which can include binary, quantitative, and/or descriptive data of the abnormality as a whole, or can correspond to one or more abnormality classifier categories **444**, which can include size, volume, pre-post contrast, doubling time, calcification, components, smoothness, spiculation, lobulation, sphericity, internal structure, texture, or other categories that can classify and/or otherwise characterize an abnormality. Abnormality classifier categories **444** can be assigned a binary value, indicating whether or not such a category is present. For example, this binary value can be determined by comparing some or all of confidence score data **460** to a threshold, can be determined by comparing a probability value to a threshold, and/or can be determined by comparing another continuous or discrete value indicating a calculated likelihood that a corresponding abnormality classifier category **444** is present to a threshold, which can be the same or different threshold for each abnormality classifier category **444**. In some embodiments, abnormality classifier categories **444** can be assigned one or more non-binary values, such as one or more continuous or discrete values indicating a likelihood that the corresponding classifier category **444** is present.

The abnormality classifier categories **444** can also include a malignancy category, and the abnormality classification data **445** can include a malignancy rating such as a Lung-RADS score, a Fleischner score, and/or one or more calculated values that indicate malignancy level, malignancy severity, and/or probability of malignancy. Alternatively or in addition, the malignancy category can be assigned a value of “yes”, “no”, or “maybe”. The abnormality classifier categories **444** can also include abnormality pattern categories **446** such as cardiomegaly, consolidation, effusion, emphysema, and/or fracture, and the abnormality classification data **445** for each abnormality pattern category **446** can indicate whether or not each of the abnormality patterns is present.

The abnormality classifier categories can correspond to Response Evaluation Criteria in Solid Tumors (RECIST) eligibility and/or RECIST evaluation categories. For example, an abnormality classifier category **444** corresponding to RECIST eligibility can have corresponding abnormality classification data **445** indicating a binary value “yes” or “no”, and/or can indicate if the abnormality is a “target lesion” and/or a “non-target lesion.” As another example, an abnormality classifier category **444** corresponding to a RECIST evaluation category can be determined based on longitudinal data **433** and can have corresponding abnormality classification data **445** that includes one of the set of possible values “Complete Response”, “Partial Response”, “Stable Disease”, or “Progressive Disease.”

The diagnosis data **440** as a whole, and/or the abnormality annotation data **442** for each abnormality, can include custom codes or datatypes identifying the binary abnormality identifier **441**, abnormality location data **443** and/or some or all of the abnormality classification data **445** of one or more abnormality classifier categories **444**. Alternatively or in

addition, some or all of the abnormality annotation data **442** for each abnormality and/or other diagnosis data **440** can be presented in a DICOM format or other standardized image annotation format, and/or can be extracted into custom datatypes based on abnormality annotation data originally presented in DICOM format. Alternatively or in addition, the diagnosis data **440** and/or the abnormality annotation data **442** for each abnormality can be presented as one or more medical codes **447** such as SNOMED codes, Current Procedure Technology (CPT) codes, ICD-9 codes, ICD-10 codes, or other standardized medical codes used to label or otherwise describe medical scans.

Alternatively or in addition, the diagnosis data **440** can include natural language text data **448** annotating or otherwise describing the medical scan as a whole, and/or the abnormality annotation data **442** can include natural language text data **448** annotating or otherwise describing each corresponding abnormality. In some embodiments, some or all of the diagnosis data **440** is presented only as natural language text data **448**. In some embodiments, some or all of the diagnosis data **440** is automatically generated by one or more subsystems based on the natural language text data **448**, for example, without utilizing the medical scan image data **410**, for example, by utilizing one or more medical scan natural language analysis functions trained by the medical scan natural language analysis system **114**. Alternatively or in addition, some embodiments, some or all of the natural language text data **448** is generated automatically based on other diagnosis data **440** such as abnormality annotation data **442**, for example, by utilizing a medical scan natural language generating function trained by the medical scan natural language analysis system **114**.

The diagnosis data can include report data **449** that includes at least one medical report, which can be formatted to include some or all of the medical codes **447**, some or all of the natural language text data **448**, other diagnosis data **440**, full or cropped images slices formatted based on the display parameter data **470** and/or links thereto, full or cropped images slices or other data based on similar scans of the similar scan data **480** and/or links thereto, full or cropped images or other data based on patient history data **430** such as longitudinal data **433** and/or links thereto, and/or other data or links to data describing the medical scan and associated abnormalities. The diagnosis data **440** can also include finalized diagnosis data corresponding to future scans and/or future diagnosis for the patient, for example, biopsy data or other longitudinal data **433** determined subsequently after the scan. The medical report of report data **449** can be formatted based on specified formatting parameters such as font, text size, header data, bulleting or numbering type, margins, file type, preferences for including one or more full or cropped image slices **412**, preferences for including similar medical scans, preferences for including additional medical scans, or other formatting to list natural language text data and/or image data, for example, based on preferences of a user indicated in the originating entity data **423** or other responsible user in the corresponding report formatting data.

Annotation author data **450** can be mapped to the diagnosis data for each abnormality, and/or mapped to the scan as a whole. This can include one or more annotation author identifiers **451**, which can include one or more user profile identifiers of a user of the system, such as an individual medical professional, medical facility and/or medical entity that uses the system. Annotation author data **450** can be used to determine the usage data of a user profile entry **354**. Annotation author data **450** can also include one or more

medical scan analysis function identifiers **357** or other function identifier indicating one or more functions or other processes of a subsystem responsible for automatically generating and/or assisting a user in generating some or all of the diagnosis data, for example an identifier of a particular type and/or version of a medical scan image analysis functions that was used by the medical scan diagnosing system **108** used to generate part or all of the diagnosis data **440** and/or an interface feature identifier, indicating an one or more interface features presented to a user to facilitate entry of and/or reviewing of the diagnosis data **440**. The annotation author data can also simply indicate, for one or more portions of the diagnosis data **440**, if this portion was generated by a human or automatically generated by a subsystem of the medical scan processing system.

In some embodiments, if a medical scan was reviewed by multiple entities, multiple, separate diagnosis data entries **440** can be included in the medical scan entry **352**, mapped to each diagnosis author in the annotation author data **450**. This allows different versions of diagnosis data **440** received from multiple entities. For example, annotation author data of a particular medical scan could indicate that the annotation data was written by a doctor at medical entity A, and the medical code data was generated by user Y by utilizing the medical scan report labeling system **104**, which was confirmed by expert user X. The annotation author data of another medical scan could indicate that the medical code was generated automatically by utilizing version 7 of the medical scan image analysis function relating to chest x-rays, and confirmed by expert user X. The annotation author data of another medical scan could indicate that the location and a first malignancy rating were generated automatically by utilizing version 7 of the medical scan image analysis function relating to chest x-rays, and that a second malignancy rating was entered by user Z. In some embodiments, one of the multiple diagnosis entries can include consensus annotation data, for example, generated automatically by a subsystem such as the medical scan annotating system **106** based on the multiple diagnosis data **440**, based on confidence score data **460** of each of the multiple diagnosis data **440**, and/or based on performance score data of a corresponding user, a medical scan analysis function, or an interface feature, identified in the annotation author data for each corresponding one of the multiple diagnosis data **440**.

Confidence score data **460** can be mapped to some or all of the diagnosis data **440** for each abnormality, and/or for the scan as a whole. This can include an overall confidence score for the diagnosis, a confidence score for the binary indicator of whether or not the scan was normal, a confidence score for the location a detected abnormality, and/or confidence scores for some or all of the abnormality classifier data. This may be generated automatically by a subsystem, for example, based on the annotation author data and corresponding performance score of one or more identified users and/or subsystem attributes such as interactive interface types or medical scan image analysis functions indicated by the annotation author data. In the case where multiple diagnosis data entries **440** are included from different sources, confidence score data **460** can be computed for each entry and/or an overall confidence score, for example, corresponding to consensus diagnosis data, can be based on calculated distance or other error and/or discrepancies between the entries, and/or can be weighted on the confidence score data **460** of each entry. In various embodiments, the confidence score data **460** can include a truth flag **461** indicating the diagnosis data is considered as "known" or

“truth”, for example, flagged based on user input, flagged automatically based on the author data, and/or flagged automatically based on the calculated confidence score of the confidence score data exceeding a truth threshold. As used herein, a “high” confidence score refers to a greater degree or more favorable level of confidence than a “low” confidence score.

Display parameter data **470** can indicate parameters indicating an optimal or preferred display of the medical scan by an interactive interface **275** and/or formatted report for each abnormality and/or for the scan as a whole. Some or all of the display parameter data can have separate entries for each abnormality, for example, generated automatically by a subsystem **101** based on the abnormality annotation data **442**. Display parameter data **470** can include interactive interface feature data **471**, which can indicate one or more selected interface features associated with the display of abnormalities and/or display of the medical scan as a whole, and/or selected interface features associated with user interaction with a medical scan, for example, based on categorized interface feature performance score data and a category associated with the abnormality and/or with the medical scan itself. The display parameter data can include a slice subset **472**, which can indicate a selected subset of the plurality of image slices that includes a single image slice **412** or multiple image slices **412** of the medical scan image data **410** for display by a user interface. The display parameter data **470** can include slice order data **473** that indicates a selected custom ordering and/or ranking for the slice subset **472**, or for all of the slices **412** of the medical scan. The display parameter data **470** can include slice cropping data **474** corresponding to some or all of the slice subset **472**, or all of the image slices **412** of the medical scan, and can indicate a selected custom cropped region of each image slice **412** for display, or the same selected custom cropped region for the slice subset **472** or for all slices **412**. The display parameter data can include density window data **475**, which can indicate a selected custom density window for display of the medical scan as a whole, a selected custom density window for the slices subset **472**, and/or selected custom density windows for each of the image slices **412** of the slice subset **472**, and/or for each image slice **412** of the medical scan. The density window data **475** can indicate a selected upper density value cut off and a selected lower density value cut off, and/or can include a selected deterministic function to map each density value of a pixel to a grayscale value based on the preferred density window. The interactive interface feature data **471**, slice subset **472**, slice order data **473**, slice cropping data **474**, and/or the density window data **475** can be selected via user input and/or generated automatically by one or more subsystems **101**, for example, based on the abnormality annotation data **442** and/or based on performance score data of different interactive interface versions.

Similar scan data **480** can be mapped to each abnormality, or the scan as a whole, and can include similar scan identifier data **481** corresponding to one or more identified similar medical scans, for example, automatically identified by a subsystem **101**, for example, by applying a similar scan identification step of the medical scan image analysis system **112** and/or applying medical scan similarity analysis function to some or all of the data stored in the medical scan entry of the medical scan, and/or to some or all corresponding data of other medical scans in the medical scan database. The similar scan data **480** can also correspond to medical scans received from another source. The stored similarity data can be used to present similar cases to users of the

system and/or can be used to train medical scan image analysis functions or medical scan similarity analysis functions.

Each identified similar medical scan can have its own medical scan entry **352** in the medical scan database **342** with its own data, and the similar scan identifier data **481** can include the medical scan identifier **353** each similar medical scan. Each identified similar medical scan can be a scan of the same scan type or different scan type than medical scan.

The similar scan data **480** can include a similarity score **482** for each identified similar scan, for example, generated based on some or all of the data of the medical scan entry **352** for medical scan and based on some or all of the corresponding data of the medical scan entry **352** for the identified similar medical scan. For example, the similarity score **482** can be generated based on applying a medical scan similarity analysis function to the medical image scan data of medical scans and **402**, to some or all of the abnormality annotation data of medical scans and **402**, and/or to some or all of the patient history data **430** of medical scans and **402** such as risk factor data **432**. As used herein, a “high” similarity score refers to a higher level of similarity than a “low” similarity score.

The similar scan data **480** can include its own similar scan display parameter data **483**, which can be determined based on some or all of the display parameter data **470** of the identified similar medical scan. Some or all of the similar scan display parameter data **483** can be generated automatically by a subsystem, for example, based on the display parameter data **470** of the identified similar medical scan, based on the abnormality annotation data **442** of the medical scan itself and/or based on display parameter data **470** of the medical scan itself. Thus, the similar scan display parameter data **483** can be the same or different than the display parameter data **470** mapped to the identified similar medical scan and/or can be the same or different than the display parameter data **470** of the medical scan itself. This can be utilized when displaying similar scans to a user via interactive interface **275** and/or can be utilized when generating report data **449** that includes similar scans, for example, in conjunction with the medical scan assisted review system **102**.

The similar scan data **480** can include similar scan abnormality data **484**, which can indicate one of a plurality of abnormalities of the identified similar medical scan and its corresponding abnormality annotation data **442**. For example, the similarity scan abnormality data **484** can include an abnormality pair that indicates one of a plurality of abnormalities of the medical scan, and indicates one of a plurality of abnormalities of the identified similar medical scan, for example, that was identified as the similar abnormality.

The similar scan data **480** can include similar scan filter data **485**. The similar scan filter data can be generated automatically by a subsystem, and can include a selected ordered or un-ordered subset of all identified similar scans of the similar scan data **480**, and/or a ranking of all identified similar scans. For example, the subset can be selected and/or some or all identified similar scans can be ranked based on each similarity score **482**, and/or based on other factors such as based on a longitudinal quality score **434** of each identified similar medical scan.

The training set data **490** can indicate one or more training sets that the medical scan belongs to. For example, the training set data can indicate one or more training set identifiers **491** indicating one or more medical scan analysis functions that utilized the medical scan in their training set,

and/or indicating a particular version identifier **641** of the one or more medical scan analysis functions that utilized the medical scan in their training set. The training set data **490** can also indicate which portions of the medical scan entry were utilized by the training set, for example, based on model parameter data **623** of the corresponding medical scan analysis functions. For example, the training set data **490** can indicate that the medical scan image data **410** was included in the training set utilized to train version X of the chest x-ray medical scan image analysis function, or that the natural language text data **448** of this medical scan was used to train version Y of the natural language analysis function.

FIG. 5 presents an embodiment of a medical scan analysis function entry **356**, stored in medical scan analysis function database **346** or otherwise associated with one of a plurality of medical scan analysis functions trained by and/or utilized by one or more subsystems **101**. For example, a medical scan analysis function can include one or more medical scan image analysis functions trained by the medical scan image analysis system **112**; one or more medical scan natural language analysis functions trained by the medical scan natural language analysis system **114**; one or more medical scan similarity analysis function trained by the medical scan image analysis system **112**, the medical scan natural language analysis system **114**, and/or the medical scan comparison system **116**; one or more medical report generator functions trained by the medical scan natural language analysis system **114** and/or the medical scan image analysis system **112**, and/or the medical report analysis function trained by the medical scan natural language analysis system **114**. Some or all of the medical scan analysis functions can correspond to medical scan inference functions of the medical scan diagnosing system **108**, the de-identification function and/or the inference functions utilized by a medical picture archive integration system as discussed in conjunction with FIGS. 8A-8F, or other functions and/or processes described herein in conjunction with one or more subsystems **101**. Each medical scan analysis function entry **356** can include a medical scan analysis function identifier **357**.

A medical scan analysis function entry **356** can include function classifier data **610**. Function classifier data **610** can include input and output types corresponding to the function. For example the function classifier data can include input scan category **611** that indicates which types of scans can be used as input to the medical scan analysis function. For example, input scan category **611** can indicate that a medical scan analysis function is for chest CT scans from a particular hospital or other medical entity. The input scan category **611** can include one or more categories included in scan classifier data **420**. In various embodiments, the input scan category **611** corresponds to the types of medical scans that were used to train the medical scan analysis function. Function classifier data **610** can also include output type data **612** that characterizes the type of output that will be produced by the function, for example, indicating that a medical scan analysis function is used to generate medical codes **447**. The input scan category **611** can also include information identifying which subsystems **101** are responsible for running the medical scan analysis function.

A medical scan analysis function entry **356** can include training parameters **620**. This can include training set data **621**, which can include identifiers for the data used to train the medical scan analysis function, such as a set of medical scan identifiers **353** corresponding to the medical scans used to train the medical scan analysis function, a list of medical scan reports and corresponding medical codes used to train the medical scan analysis function, etc. Alternatively or in

addition to identifying particular scans of the training set, the training set data **621** can identify training set criteria, such as necessary scan classifier data **420**, necessary abnormality locations, classifiers, or other criteria corresponding to abnormality annotation data **442**, necessary confidence score data **460**, for example, indicating that only medical scans with diagnosis data **440** assigned a truth flag **461** or with confidence score data **460** otherwise comparing favorably to a training set confidence score threshold are included, a number of medical scans to be included and proportion data corresponding to different criteria, or other criteria used to populate a training set with data of medical scans. Training parameters **620** can include model type data **622** indicating one or more types of model, methods, and/or training functions used to determine the medical scan analysis function by utilizing the training set **621**. Training parameters **620** can include model parameter data **623** that can include a set of features of the training data selected to train the medical scan analysis function, determined values for weights corresponding to selected input and output features, determined values for model parameters corresponding to the model itself, etc. The training parameter data can also include testing data **624**, which can identify a test set of medical scans or other data used to test the medical scan analysis function. The test set can be a subset of training set **621**, include completely separate data than training set **621**, and/or overlap with training set **621**. Alternatively or in addition, testing data **624** can include validation parameters such as a percentage of data that will be randomly or pseudo-randomly selected from the training set for testing, parameters characterizing a cross validation process, or other information regarding testing. Training parameters **620** can also include training error data **625** that indicates a training error associated with the medical scan analysis function, for example, based on applying cross validation indicated in testing data **624**.

A medical scan analysis function entry **356** can include performance score data **630**. Performance data can include model accuracy data **631**, for example, generated and/or updated based on the accuracy of the function when performed on new data. For example, the model accuracy data **631** can include or be calculated based on the model error for determined for individual uses, for example, generated by comparing the output of the medical scan analysis function to corresponding data generated by user input to interactive interface **275** in conjunction with a subsystem **101** and/or generated by comparing the output of the medical scan analysis function to medical scans with a truth flag **461**. The model accuracy data **631** can include aggregate model accuracy data computed based on model error of individual uses of the function over time. The performance score data **630** can also include model efficiency data **632**, which can be generated based on how quickly the medical scan analysis function performs, how much memory is utilized by medical scan analysis function, or other efficiency data relating to the medical scan analysis function. Some or all of the performance score data **630** can be based on training error data **625** or other accuracy and/or efficiency data determined during training and/or validation. As used herein, a "high" performance score refers to a more favorable performance or rating than a "low" performance score.

A medical scan analysis function entry **356** can include version data **640**. The version data can include a version identifier **641**. The version data can indicate one or more previous version identifiers **642**, which can map to version identifiers **641** stored in other medical scan analysis function entry **356** that correspond to previous versions of the func-

tion. Alternatively or in addition, the version data can indicate multiple versions of the same type based on function classifier data **610**, can indicate the corresponding order and/or rank of the versions, and/or can indicate training parameters **620** associated with each version.

A medical scan analysis function entry **356** can include remediation data **650**. Remediation data **650** can include remediation instruction data **651** which can indicate the steps in a remediation process indicating how a medical scan analysis function is taken out of commission and/or reverted to a previous version in the case that remediation is necessary. The version data **640** can further include remediation criteria data **652**, which can include threshold data or other criteria used to automatically determine when remediation is necessary. For example, the remediation criteria data **652** can indicate that remediation is necessary at any time where the model accuracy data and/or the model efficiency data compares unfavorably to an indicated model accuracy threshold and/or indicated model efficiency threshold. The remediation data **650** can also include recommissioning instruction data **653**, identifying required criteria for recommissioning a medical scan analysis function and/or updating a medical scan analysis function. The remediation data **650** can also include remediation history, indicating one or more instances that the medical scan analysis function was taken out of commission and/or was recommissioned.

FIGS. **6A** and **6B** present an embodiment of a medical scan diagnosing system **108**. The medical scan diagnosing system **108** can generate inference data **1110** for medical scans by utilizing a set of medical scan inference functions **1105**, stored and run locally, stored and run by another subsystem **101**, and/or stored in the medical scan analysis function database **346**, where the function and/or parameters of the function can be retrieved from the database by the medical scan diagnosing system. For example, the set of medical scan inference function **1105** can include some or all medical scan analysis functions described herein or other functions that generate inference data **1110** based on some or all data corresponding to a medical scan such as some or all data of a medical scan entry **352**. Each medical scan inference function **1105** in the set can correspond to a scan category **1120**, and can be trained on a set of medical scans that compare favorably to the scan category **1120**. For example, each inference function can be trained on a set of medical scans of the one or more same scan classifier data **420**, such as the same and/or similar scan types, same and/or similar anatomical regions locations, same and/or similar machine models, same and/or similar machine calibration, same and/or similar contrasting agent used, same and/or similar originating entity, same and/or similar geographical region, and/or other classifiers. Thus, the scan categories **1120** can correspond to one or more of a scan type, scan anatomical region data, hospital or other originating entity data, machine model data, machine calibration data, contrast agent data, geographic region data, and/or other scan classifying data **420**. For example, a first medical scan inference function can be directed to characterizing knee x-rays, and a second medical scan inference function can be directed to chest CT scans. As another example, a first medical scan inference function can be directed to characterizing CT scans from a first hospital, and a second medical scan image analysis function can be directed to characterizing CT scans from a second hospital.

Training on these categorized sets separately can ensure each medical scan inference function **1105** is calibrated according to its scan category **1120**, for example, allowing different inference functions to be calibrated on type spe-

cific, anatomical region specific, hospital specific, machine model specific, and/or region-specific tendencies and/or discrepancies. Some or all of the medical scan inference functions **1105** can be trained by the medical scan image analysis system and/or the medical scan natural language processing system, and/or some medical scan inference functions **1105** can utilize both image analysis and natural language analysis techniques to generate inference data **1110**. For example, some or all of the inference functions can utilize image analysis of the medical scan image data **410** and/or natural language data extracted from abnormality annotation data **442** and/or report data **449** as input, and generate diagnosis data **440** such as medical codes **447** as output. Each medical scan inference function can utilize the same or different learning models to train on the same or different features of the medical scan data, with the same or different model parameters, for example indicated in the model type data **622** and model parameter data **623**. Model type and/or parameters can be selected for a particular medical scan inference function based on particular characteristics of the one or more corresponding scan categories **1120**, and some or all of the indicated in the model type data **622** and model parameter data **623** can be selected automatically by a subsystem during the training process based on the particular learned and/or otherwise determined characteristics of the one or more corresponding scan categories **1120**.

As shown in FIG. **6A**, the medical scan diagnosing system **108** can automatically select a medical scan for processing in response to receiving it from a medical entity via the network. Alternatively, the medical scan diagnosing system **108** can automatically retrieve a medical scan from the medical scan database that is selected based on a request received from a user for a particular scan and/or based on a queue of scans automatically ordered by the medical scan diagnosing system **108** or another subsystem based on scan priority data **427**.

Once a medical scan to be processed is determined, the medical scan diagnosing system **108** can automatically select an inference function **1105** based on a determined scan category **1120** of the selected medical scan and based on corresponding inference function scan categories. The scan category **1120** of a scan can be determined based on some or all of the scan classifier data **420** and/or based on other metadata associated with the scan. This can include determining which one of the plurality of medical scan inference functions **1105** matches or otherwise compares favorably to the scan category **1120**, for example, by comparing the scan category **1120** to the input scan category of the function classifier data **610**.

Alternatively or in addition, the medical scan diagnosing system **108** can automatically determine which medical scan inference function **1105** is utilized based on an output preference that corresponding to a desired type of inference data **1110** that is outputted by an inference function **1105**. The output preference designated by a user of the medical scan diagnosing system **108** and/or based on the function of a subsystem **101** utilizing the medical scan diagnosing system **108**. For example, the set of inference functions **1105** can include inference functions that are utilized to indicate whether or not a medical scan is normal, to automatically identify at least one abnormality in the scan, to automatically characterize the at least one abnormality in the scan, to assign one or more medical codes to the scan, to generate natural language text data and/or a formatted report for the scan, and/or to automatically generate other diagnosis data such as some or all of diagnosis data **440** based on the

medical scan. Alternatively or in addition, some inference functions can also be utilized to automatically generate confidence score data **460**, display parameter data **470**, and/or similar scan data **480**. The medical scan diagnosing system **108** can compare the output preference to the output type data **612** of the medical scan inference function **1105** to determine the selected inference function **1105**. For example, this can be used to decide between a first medical scan inference function that automatically generates medical codes and a second medical scan inference function that automatically generates natural language text for medical reports based on the desired type of inference data **1110**.

Prior to performing the selected medical scan inference function **1105**, the medical scan diagnosing system **108** can automatically perform an input quality assurance function **1106** to ensure the scan classifier data **420** or other metadata of the medical scan accurately classifies the medical scan such that the appropriate medical scan inference function **1105** of the appropriate scan category **1120** is selected. The input quality assurance function can be trained on, for example, medical scan image data **410** of plurality of previous medical scans with verified scan categories. Thus, the input quality assurance function **1106** can take medical scan image data **410** as input and can generate an inferred scan category as output. The inferred scan category can be compared to the scan category **1120** of the scan, and the input quality assurance function **1106** can determine whether or not the scan category **1120** is appropriate by determining whether the scan category **1120** compares favorably to the automatically generated inferred scan category. The input quality assurance function **1106** can also be utilized to reassign the generated inferred scan category to the scan category **1120** when the scan category **1120** compares favorably to the automatically generated inferred scan category. The input quality assurance function **1106** can also be utilized to assign the generated inferred scan category to the scan category **1120** for incoming medical scans that do not include any classifying data, and/or to add classifiers in scan classifier data **420** to medical scans missing one or more classifiers.

In various embodiments, upon utilizing the input quality assurance function **1106** to determine that the scan category **1120** determined by a scan classifier data **420** or other metadata is inaccurate, the medical scan diagnosing system **108** can transmit an alert and/or an automatically generated inferred scan category to the medical entity indicating that the scan is incorrectly classified in the scan classifier data **420** or other metadata. In some embodiments, the medical scan diagnosing system **108** can automatically update performance score data corresponding to the originating entity of the scan indicated in originating entity data **423**, or another user or entity responsible for classifying the scan, for example, where a lower performance score is generated in response to determining that the scan was incorrectly classified and/or where a higher performance score is generated in response to determining that the scan was correctly classified.

In some embodiments, the medical scan diagnosing system **108** can transmit the medical scan and/or the automatically generated inferred scan category to a selected user. The user can be presented the medical scan image data **410** and/or other data of the medical scan via the interactive interface **275**, for example, displayed in conjunction with the medical scan assisted review system **102**. The interface can prompt the user to indicate the appropriate scan category **1120** and/or prompt the user to confirm and/or edit the inferred scan category, also presented to the user. For

example, scan review data can be automatically generated to reflect the user generated and/or verified scan category **1120**. This user indicated scan category **1120** can be utilized to select to the medical scan inference function **1105** and/or to update the scan classifier data **420** or other metadata accordingly. In some embodiments, for example, where the scan review data indicates that the selected user disagrees with the automatically generated inferred scan category created by the input quality assurance function **1106**, the medical scan diagnosing system **108** can automatically update performance score data **630** of the input quality assurance function **1106** by generating a low performance score and/or determine to enter the remediation step **1140** for the input quality assurance function **1106**.

The medical scan diagnosing system **108** can also automatically perform an output quality assurance step after a medical scan inference function **1105** has been performed on a medical scan to produce the inference data **1110**, as illustrated in the embodiment presented in FIG. **6B**. The output quality assurance step can be utilized to ensure that the selected medical scan inference function **1105** generated appropriate inference data **1110** based on expert feedback. The inference data **1110** generated by performing the selected medical scan inference function **1105** can be sent to a client device **120** of a selected expert user, such as an expert user in the user database selected based on categorized performance data and/or qualification data that corresponds to the scan category **1120** and/or the inference itself, for example, by selecting an expert user best suited to review an identified abnormality classifier category **444** and/or abnormality pattern category **446** in the inference data **1110** based on categorized performance data and/or qualification data of a corresponding user entry. The selected user can also correspond to a medical professional or other user employed at the originating entity and/or corresponding to the originating medical professional, indicated in the originating entity data **423**.

FIG. **6B** illustrates an embodiment of the medical scan diagnosing system **108** in conjunction with performing a remediation step **1140**. The medical scan diagnosing system **108** can monitor the performance of the set of medical scan inference functions **1105**, for example, based on evaluating inference accuracy data outputted by an inference data evaluation function and/or based monitoring on the performance score data **630** in the medical scan analysis function database, and can determine whether or not if the corresponding medical scan inference function **1105** is performing properly. This can include, for example, determining if a remediation step **1140** is necessary for a medical scan inference function **1105**, for example, by comparing the performance score data **630** and/or inference accuracy data to remediation criteria data **652**. Determining if a remediation step **1140** is necessary can also be based on receiving an indication from the expert user or another user that remediation is necessary for one or more identified medical scan inference functions **1105** and/or for all of the medical scan inference functions **1105**.

In various embodiments, a remediation evaluation function is utilized to determine if a remediation step **1140** is necessary for medical scan inference function **1105**. The remediation evaluation function can include determining that remediation is necessary when recent accuracy data and/or efficiency data of a particular medical scan inference function **1105** is below the normal performance level of the particular inference function. The remediation evaluation function can include determining that remediation is necessary when recent or overall accuracy data and/or efficiency

data of a particular medical scan inference function **1105** is below a recent or overall average for all or similar medical scan inference functions **1105**. The remediation evaluation function can include determining that remediation is necessary only after a threshold number of incorrect diagnoses are made. In various embodiments, multiple threshold number of incorrect diagnoses correspond to different diagnoses categories. For example, the threshold number of incorrect diagnoses for remediation can be higher for false negative diagnoses than false positive diagnoses. Similarly, categories corresponding to different diagnosis severities and/or rarities can have different thresholds, for example where a threshold number of more severe and/or more rare diagnoses that were inaccurate to necessitate remediation is lower than a threshold number of less severe and/or less rare diagnoses that were inaccurate.

The remediation step **1140** can include automatically updating an identified medical inference function **1105**. This can include automatically retraining identified medical inference function **1105** on the same training set or on a new training set that includes new data, data with higher corresponding confidence scores, or data selected based on new training set criteria. The identified medical inference function **1105** can also be updated and/or changed based on the review data received from the client device. For example, the medical scan and expert feedback data can be added to the training set of the medical scan inference function **1105**, and the medical scan inference function **1105** can be retrained on the updated training set. Alternatively or in addition, the expert user can identify additional parameters and/or rules in the expert feedback data based on the errors made by the inference function in generating the inference data **1110** for the medical scan, and these parameters and/or rules can be applied to update the medical scan inference function, for example, by updating the model type data **622** and/or model parameter data **623**.

The remediation step **1140** can also include determining to split a scan category **1120** into two or more subcategories. Thus, two or more new medical scan inference functions **1105** can be created, where each new medical scan inference functions **1105** is trained on a corresponding training set that is a subset of the original training set and/or includes new medical scan data corresponding to the subcategory. This can allow medical scan inference functions **1105** to become more specialized and/or allow functions to utilize characteristics and/or discrepancies specific to the subcategory when generating inference data **1110**. Similarly, a new scan category **1120** that was not previously represented by any of the medical scan inference functions **1105** can be added in the remediation step, and a new medical scan inference functions **1105** can be trained on a new set of medical scan data that corresponds to the new scan category **1120**. Splitting a scan category and/or adding a scan category can be determined automatically by the medical scan diagnosing system **108** when performing the remediation step **1140**, for example, based on performance score data **630**. This can also be determined based on receiving instructions to split a category and/or add a new scan category from the expert user or other user of the system.

After a medical scan inference function **1105** is updated or created for the first time, the remediation step **1140** can further undergo a commissioning test, which can include rigorous testing of the medical scan inference function **1105** on a testing set, for example, based on the training parameters **620**. For example, the commissioning test can be passed when the medical scan inference function **1105** generates a threshold number of correct inference data **1110**

and/or the test can be passed if an overall or average discrepancy level between the inference data and the test data is below a set error threshold. The commissioning test can also evaluate efficiency, where the medical scan inference function **1105** only passes the commissioning test if it performs at or exceeds a threshold efficiency level. If the medical scan inference function **1105** fails the commissioning test, the model type and/or model parameters can be modified automatically or based on user input, and the medical scan inference function can be retested, continuing this process until the medical scan inference function **1105** passes the commissioning test.

The remediation step **1140** can include decommissioning the medical scan inference function **1105**, for example, while the medical scan inference function is being retrained and/or is undergoing the commissioning test. Incoming scans to the medical scan diagnosing system **108** with a scan category **1120** corresponding to a decommissioned medical scan inference function **1105** can be sent directly to review by one or more users, for example, in conjunction with the medical scan annotator system **106**. These user-reviewed medical scans and corresponding annotations can be included in an updated training set used to train the decommissioned medical scan inference function **1105** as part of the remediation step **1140**. In some embodiments, previous versions of the plurality of medical scan image analysis functions can be stored in memory of the medical scan diagnosing system and/or can be determined based on the version data **640** of a medical scan inference function **1105**. A previous version of a medical scan inference function **1105**, such as most recent version or version with the highest performance score, can be utilized during the remediation step **1140** as an alternative to sending all medical scans to user review.

A medical scan inference function can also undergo the remediation step **1140** automatically in response to a hardware and/or software update on processing, memory, and/or other computing devices where the medical scan inference function **1105** is stored and/or performed. Different medical scan inference functions **1105** can be containerized on their own devices by utilizing a micro-service architecture, so hardware and/or software updates may only necessitate that one of the medical scan inference functions **1105** undergo the remediation step **1140** while the others remain unaffected. A medical scan inference function **1105** can also undergo the remediation step **1140** automatically in response to normal system boot-up, and/or periodically in fixed intervals. For example, in response to a scheduled or automatically detected hardware and/or software update, change, or issue, one or more medical scan inference functions **1105** affected by this hardware or software can be taken out of commission until they each pass the commissioning test. Such criteria can be indicated in the remediation criteria data **652**.

The medical scan diagnosing system **108** can automatically manage usage data, subscription data, and/or billing data for the plurality of users corresponding to user usage of the system, for example, by utilizing, generating, and/or updating some or all of the subscription data of the user database. Users can pay for subscriptions to the system, which can include different subscription levels that can correspond to different costs. For example, a hospital can pay a monthly cost to automatically diagnose up to 100 medical scans per month. The hospital can choose to upgrade their subscription or pay per-scan costs for automatic diagnosing of additional scans received after the quota is reached and/or the medical scan diagnosing system **108**

can automatically send medical scans received after the quota is reached to an expert user associated with the hospital. In various embodiments incentive programs can be used by the medical scan diagnosing system to encourage experts to review medical scans from different medical entities. For example, an expert can receive credit to their account and/or subscription upgrades for every medical scan reviewed, or after a threshold number of medical scans are reviewed. The incentive programs can include interactions by a user with other subsystems, for example, based on contributions made to medical scan entries via interaction with other subsystems.

FIG. 7A presents an embodiment of a medical scan image analysis system 112. A training set of medical scans used to train one more medical scan image analysis functions can be received from one or more client devices via the network and/or can be retrieved from the medical scan database 342, for example, based on training set data 621 corresponding to medical scan image analysis functions. Training set criteria, for example, identified in training parameters 620 of the medical scan image analysis function, can be utilized to automatically identify and select medical scans to be included in the training set from a plurality of available medical scans. The training set criteria can be automatically generated based on, for example, previously learned criteria, and/or training set criteria can be received via the network, for example, from an administrator of the medical scan image analysis system. The training set criteria can include a minimum training set size. The training set criteria can include data integrity requirements for medical scans in the training set such as requiring that the medical scan is assigned a truth flag 461, requiring that performance score data for a hospital and/or medical professional associated with the medical scan compares favorably to a performance score threshold, requiring that the medical scan has been reviewed by at least a threshold number of medical professionals, requiring that the medical scan and/or a diagnosis corresponding to a patient file of the medical scan is older than a threshold elapsed time period, or based on other criteria intended to insure that the medical scans and associated data in the training set is reliable enough to be considered “truth” data. The training set criteria can include longitudinal requirements such the number of required subsequent medical scans for the patient, multiple required types of additional scans for the patient, and/or other patient file requirements.

The training set criteria can include quota and/or proportion requirements for one or more medical scan classification data. For example, the training set criteria can include meeting quota and/or proportion requirements for one or more scan types and/or human body location of scans, meeting quota or proportion requirements for a number of normal medical scans and a number of medical scans with identified abnormalities, meeting quota and/or proportion requirements for a number of medical scans with abnormalities in certain locations and/or a number of medical scans with abnormalities that meet certain size, type, or other characteristics, meeting quota and/or proportion data for a number of medical scans with certain diagnosis or certain corresponding medical codes, and/or meeting other identified quota and/or proportion data relating to metadata, patient data, or other data associated with the medical scans.

In some embodiments, multiple training sets are created to generate corresponding medical scan image analysis functions, for example, corresponding to some or all of the set of medical scan inference functions 1105. Some or all training sets can be categorized based on some or all of the

scan classifier data 420 as described in conjunction with the medical scan diagnosing system 108, where medical scans are included in a training set based on their scan classifier data 420 matching the scan category of the training set. In some embodiments, the input quality assurance function 1106 or another input check step can be performed on medical scans selected for each training set to confirm that their corresponding scan classifier data 420 is correct. In some embodiments, the input quality assurance function can correspond to its own medical scan image analysis function, trained by the medical scan image analysis system, where the input quality assurance function utilizes high level computer vision technology to determine a scan category 1120 and/or to confirm the scan classifier data 420 already assigned to the medical scan.

In some embodiments, the training set will be used to create a single neural network model, or other model corresponding to model type data 622 and/or model parameter data 623 of the medical scan image analysis function that can be trained on some or all of the medical scan classification data described above and/or other metadata, patient data, or other data associated with the medical scans. In other embodiments, a plurality of training sets will be created to generate a plurality of corresponding neural network models, where the multiple training sets are divided based on some or all of the medical scan classification data described above and/or other metadata, patient data, or other data associated with the medical scans. Each of the plurality of neural network models can be generated based on the same or different learning algorithm that utilizes the same or different features of the medical scans in the corresponding one of the plurality of training sets. The medical scan classifications selected to segregate the medical scans into multiple training sets can be received via the network, for example based on input to an administrator client device from an administrator. The medical scan classifications selected to segregate the medical scans can be automatically determined by the medical scan image analysis system, for example, where an unsupervised clustering algorithm is applied to the original training set to determine appropriate medical scan classifications based on the output of the unsupervised clustering algorithm.

In embodiments where the medical scan image analysis system is used in conjunction with the medical scan diagnosing system, each of the medical scan image analysis functions associated with each neural network model can correspond to one of the plurality of neural network models generated by the medical scan image analysis system. For example, each of the plurality of neural network models can be trained on a training set classified on scan type, scan human body location, hospital or other originating entity data, machine model data, machine calibration data, contrast agent data, geographic region data, and/or other scan classifying data as discussed in conjunction with the medical scan diagnosing system. In embodiments where the training set classifiers are learned, the medical scan diagnosing system can determine which of the medical scan image analysis functions should be applied based on the learned classifying criteria used to segregate the original training set.

A computer vision-based learning algorithm used to create each neural network model can include selecting a three-dimensional subregion 1310 for each medical scan in the training set. This three-dimensional subregion 1310 can correspond to a region that is “sampled” from the entire scan that may represent a small fraction of the entire scan. Recall that a medical scan can include a plurality of ordered cross-sectional image slices. Selecting a three-dimensional

subregion **1310** can be accomplished by selecting a proper image slice subset **1320** of the plurality of cross-sectional image slices from each of the plurality of medical scans, and by further selecting a two-dimensional subregion **1330** from each of the selected subset of cross-sectional image slices of the each of the medical scans. In some embodiments, the selected image slices can include one or more non-consecutive image slices and thus a plurality of disconnected three-dimensional subregions will be created. In other embodiments, the selected proper subset of the plurality of image slices correspond to a set of consecutive image slices, as to ensure that a single, connected three-dimensional subregion is selected. In some embodiments, entire scans of the training set are used to train the neural network model. In such embodiment, as used herein, the three-dimensional subregion **1310** can refer to all of the medical scan image data **410** of a medical scan.

In some embodiments, a density windowing step can be applied to the full scan or the selected three-dimensional subregion. The density windowing step can include utilizing a selected upper density value cut off and/or a selected lower density value cut off, and masking pixels with higher values than the upper density value cut off and/or masking pixels with lower values than the lower density value cut off. The upper density value cut off and/or a selected lower density value cut off can be determined based on the range and/or distribution of density values included in the region that includes the abnormality, and/or based on the range and/or distribution of density values associated with the abnormality itself, based on user input to a subsystem, based on display parameter data associated with the medical scan or associated with medical scans of the same type, and/or can be learned in the training step. In some embodiments, a non-linear density windowing function can be applied to alter the pixel density values, for example, to stretch or compress contrast. In some embodiments, this density windowing step can be performed as a data augmenting step, to create additional training data for a medical scan in accordance with different density windows.

Having determined the subregion training set **1315** of three-dimensional subregions **1310** corresponding to the set of full medical scans in the training set, the medical scan image analysis system can complete a training step **1352** by performing a learning algorithm on the plurality of three-dimensional subregions to generate model parameter data **1355** of a corresponding learning model. The learning model can include one or more of a neural network, an artificial neural network, a convolutional neural network, a Bayesian model, a support vector machine model, a cluster analysis model, or other supervised or unsupervised learning model. The model parameter data **1355** can be generated by performing the learning algorithm **1350**, and the model parameter data **1355** can be utilized to determine the corresponding medical scan image analysis functions. For example, some or all of the model parameter data **1355** can be mapped to the medical scan analysis function in the model parameter data **623** or can otherwise define the medical scan analysis function.

The training step **1352** can include creating feature vectors for each three-dimensional subregion of the training set for use by the learning algorithm **1350** to generate the model parameter data **1355**. The feature vectors can include the pixel data of the three-dimensional subregions such as density values and/or grayscale values of each pixel based on a determined density window. The feature vectors can also include other features as additional input features or desired output features, such as known abnormality data

such as location and/or classification data, patient history data such as risk factor data or previous medical scans, diagnosis data, responsible medical entity data, scan machinery model or calibration data, contrast agent data, medical code data, annotation data that can include raw or processed natural language text data, scan type and/or anatomical region data, or other data associated with the image, such as some or all data of a medical scan entry **352**. Features can be selected based on administrator instructions received via the network and/or can be determined based on determining a feature set that reduces error in classifying error, for example, by performing a cross-validation step on multiple models created using different feature sets. The feature vector can be split into an input feature vector and output feature vector. The input feature vector can include data that will be available in subsequent medical scan input, which can include for example, the three-dimensional subregion pixel data and/or patient history data. The output feature vector can include data that will be inferred in subsequent medical scan input and can include single output value, such as a binary value indicating whether or not the medical scan includes an abnormality or a value corresponding to one of a plurality of medical codes corresponding to the image. The output feature vector can also include multiple values which can include abnormality location and/or classification data, diagnosis data, or other output. The output feature vector can also include a determined upper density value cut off and/or lower density value cut off, for example, characterizing which pixel values were relevant to detecting and/or classifying an abnormality. Features included in the output feature vector can be selected to include features that are known in the training set, but may not be known in subsequent medical scans such as triaged scans to be diagnosed by the medical scan diagnosing system, and/or scans to be labeled by the medical scan report labeling system. The set of features in the input feature vector and output feature vector, as well as the importance of different features where each feature is assigned a corresponding weight, can also be designated in the model parameter data **1355**.

Consider a medical scan image analysis function that utilizes a neural network. The neural network can include a plurality of layers, where each layer includes a plurality of neural nodes. Each node in one layer can have a connection to some or all nodes in the next layer, where each connection is defined by a weight value. Thus, the model parameter data **1355** can include a weight vector that includes weight values for every connection in the network. Alternatively or in addition, the model parameter data **1355** can include any vector or set of parameters associated with the neural network model, which can include an upper density value cut off and/or lower density value cut off used to mask some of the pixel data of an incoming image, kernel values, filter parameters, bias parameters, and/or parameters characterizing one or more of a plurality of convolution functions of the neural network model. The medical scan image analysis function can be utilized to produce the output vector as a function of the input feature vector and the model parameter data **1355** that characterizes the neural network model. In particular, the medical scan image analysis function can include performing a forward propagation step plurality of neural network layers to produce an inferred output vector based on the weight vector or other model parameter data **1355**. Thus, the learning algorithm **1350** utilized in conjunction with a neural network model can include determining the model parameter data **1355** corresponding to the neural

network model, for example, by populating the weight vector with optimal weights that best reduce output error.

In particular, determining the model parameter data **1355** can include utilizing a backpropagation strategy. The forward propagation algorithm can be performed on at least one input feature vector corresponding to at least one medical scan in the training set to propagate the at least one input feature vector through the plurality of neural network layers based on initial and/or default model parameter data **1355**, such as an initial weight vector of initial weight values set by an administrator or chosen at random. The at least one output vector generated by performing the forward propagation algorithm on the at least one input feature vector can be compared to the corresponding at least one known output feature vector to determine an output error. Determining the output error can include, for example, computing a vector distance such as the Euclidian distance, or squared Euclidian distance, between the produced output vector and the known output vector, and/or determining an average output error such as an average Euclidian distance or squared Euclidian distance if multiple input feature vectors were employed. Next, gradient descent can be performed to determine an updated weight vector based on the output error or average output error. This gradient descent step can include computing partial derivatives for the error with respect to each weight, or other parameter in the model parameter data **1355**, at each layer starting with the output layer. Chain rule can be utilized to iteratively compute the gradient with respect to each weight or parameter at each previous layer until all weight's gradients are computed. Next updated weights, or other parameters in the model parameter data **1355**, are generated by updating each weight based on its corresponding calculated gradient. This process can be repeated on at least one input feature vector, which can include the same or different at least one feature vector used in the previous iteration, based on the updated weight vector and/or other updated parameters in the model parameter data **1355** to create a new updated weight vector and/or other new updated parameters in the model parameter data **1355**. This process can continue to repeat until the output error converges, the output error is within a certain error threshold, or another criterion is reached to determine the most recently updated weight vector and/or other model parameter data **1355** is optimal or otherwise determined for selection.

Having determined the medical scan neural network and its final other model parameter data **1355**, an inference step **1354** can be performed on new medical scans to produce inference data **1370**, such as inferred output vectors, as shown in FIG. 7B. The inference step can include performing the forward propagation algorithm to propagate an input feature vector through a plurality of neural network layers based on the final model parameter data **1355**, such as the weight values of the final weight vector, to produce the inference data. This inference step **1354** can correspond to performing the medical scan image analysis function, as defined by the final model parameter data **1355**, on new medical scans to generate the inference data **1370**, for example, in conjunction with the medical scan diagnosing system **108** to generate inferred diagnosis data or other selected output data for triaged medical scans based on its corresponding the input feature vector.

The inference step **1354** can include applying the density windowing step to new medical scans. Density window cut off values and/or a non-linear density windowing function that are learned can be automatically applied when performing the inference step. For example, if the training step **1352** was used to determine optimal upper density value cut off

and/or lower density value cut off values to designate an optimal density window, the inference step **1354** can include masking pixels of incoming scans that fall outside of this determined density window before applying the forward propagation algorithm. As another example, if learned parameters of one or more convolutional functions correspond to the optimal upper density value cut off and/or lower density value cut off values, the density windowing step is inherently applied when the forward propagation algorithm is performed on the new medical scans.

In some embodiments where a medical scan analysis function is defined by model parameter data **1355** corresponding to a neural network model, the neural network model can be a fully convolutional neural network. In such embodiments, only convolution functions are performed to propagate the input feature vector through the layers of the neural network in the forward propagation algorithm. This enables the medical scan image analysis functions to process input feature vectors of any size. For example, as discussed herein, the pixel data corresponding to the three-dimensional subregions is utilized input to the forward propagation algorithm when the training step **1352** is employed to populate the weight vector and/or other model parameter data **1355**. However, when performing the forward propagation algorithm in the inference step **1354**, the pixel data of full medical scans can be utilized as input, allowing the entire scan to be processed to detect and/or classify abnormalities, or otherwise generate the inference data **1370**. This may be a preferred embodiment over other embodiments where new scans must also be sampled by selecting a three-dimensional subregions and/or other embodiments where the inference step requires "piecing together" inference data **1370** corresponding to multiple three-dimensional subregions processed separately.

The inferred output vector of the inference data **1370** can include a plurality of abnormality probabilities mapped to a pixel location of each of a plurality of cross-sectional image slices of the new medical scan. For example, the inferred output vector can indicate a set of probability matrices **1371**, where each matrix in the set corresponds to one of the plurality of image slices of the medical scan, where each matrix is a size corresponding to the number of pixels in each image slice, where each cell of each matrix corresponds to a pixel of the corresponding image slice, whose value is the abnormality probability of the corresponding pixel.

A detection step **1372** can include determining if an abnormality is present in the medical scan based on the plurality of abnormality probabilities. Determining if an abnormality is present can include, for example, determining that a cluster of pixels in the same region of the medical scan correspond to high abnormality probabilities, for example, where a threshold proportion of abnormality probabilities must meet or exceed a threshold abnormality probability, where an average abnormality probability of pixels in the region must meet or exceed a threshold abnormality probability, where the region that includes the cluster of pixels must be at least a certain size, etc. Determining if an abnormality is present can also include calculating a confidence score based on the abnormality probabilities and/or other data corresponding to the medical scan such as patient history data. The location of the detected abnormality can be determined in the detection step **1372** based on the location of the pixels with the high abnormality probabilities. The detection step can further include determining an abnormality region **1373**, such as a two-dimensional subregion on one or more image slices that includes some or all of the abnormality. The abnormality region **1373** determined in the

detection step **1372** can be mapped to the medical scan to populate some or all of the abnormality location data **443** for use by one or more other subsystems **101** and/or client devices **120**. Furthermore, determining whether or not an abnormality exists in the detection step **1372** can be used to populate some or all of the diagnosis data **440** of the medical scan, for example, to indicate that the scan is normal or contains an abnormality in the diagnosis data **440**.

An abnormality classification step **1374** can be performed on a medical scan in response to determining an abnormality is present. Classification data **1375** corresponding to one or more classification categories such as abnormality size, volume, pre-post contract, doubling time, calcification, components, smoothness, texture, diagnosis data, one or more medical codes, a malignancy rating such as a Lung-RADS score, or other classifying data as described herein can be determined based on the detected abnormality. The classification data **1375** generated by the abnormality classification step **1374** can be mapped to the medical scan to populate some or all of the abnormality classification data **445** of the corresponding abnormality classifier categories **444** and/or abnormality pattern categories **446** and/or to determine one or more medical codes **447** of the medical scan. The abnormality classification step **1374** can include performing an abnormality classification function on the full medical scan, or the abnormality region **1373** determined in the detection step **1372**. The abnormality classification function can be based on another model trained on abnormality data such as a support vector machine model, another neural network model, or any supervised classification model trained on medical scans, or portions of medical scans, that include known abnormality classifying data to generate inference data for some or all of the classification categories. For example, the abnormality classification function can include another medical scan analysis function. Classification data **1375** in each of a plurality of classification categories can also be assigned their own calculated confidence score, which can also be generated by utilizing the abnormality classification function. Output to the abnormality classification function can also include at least one identified similar medical scan and/or at least one identified similar cropped image, for example, based on the training data. The abnormality classification step can also be included in the inference step **1354**, where the inferred output vector or other inference data **1370** of the medical scan image analysis function includes the classification data **1375**.

The abnormality classification function can be trained on full medical scans and/or one or more cropped or full selected image slices from medical scans that contain an abnormality. For example, the abnormality classification function can be trained on a set of two-dimensional cropped slices that include abnormalities. The selected image slices and/or the cropped region in each selected image slice for each scan in the training set can be automatically selected based upon the known location of the abnormality. Input to the abnormality classification function can include the full medical scan, one or more selected full image slices, and/or one or more selected image slices cropped based on a selected region. Thus, the abnormality classification step can include automatically selecting one or more image slices that include the detected abnormality. The slice selection can include selecting the center slice in a set of consecutive slices that are determined to include the abnormality or selecting a slice that has the largest cross-section of the abnormality, or selecting one or more slices based on other criteria. The abnormality classification step can also include automatically generating one or more cropped two-dimen-

sional images corresponding to the one or more of the selected image slices based on an automatically selected region that includes the abnormality.

Input to the abnormality classification function can also include other data associated with the medical scan, including patient history, risk factors, or other metadata. The abnormality classification step can also include determining some or all of the characteristics based on data of the medical scan itself. For example, the abnormality size and volume can be determined based on a number of pixels determined to be part of the detected abnormality. Other classifiers such as abnormality texture and/or smoothness can be determined by performing one or more other preprocessing functions on the image specifically designed to characterize such features. Such preprocessed characteristics can be included in the input to the abnormality classification function to the more difficult task of assigning a medical code or generating other diagnosis data. The training data can also be preprocessed to include such preprocessed features.

A similar scan identification step **1376** can also be performed on a medical scan with a detected abnormality and/or can be performed on the abnormality region **1373** determined in the detection step **1372**. The similar scan identification step **1376** can include generating similar abnormality data **1377**, for example, by identifying one or more similar medical scans or one or more similar cropped two-dimensional images from a database of medical scans and/or database of cropped two-dimensional images. Similar medical scans and/or cropped images can include medical scans or cropped images that are visually similar, medical scans or cropped images that have known abnormalities in a similar location to an inferred abnormality location of the given medical scan, medical scans that have known abnormalities with similar characteristics to inferred characteristics of an abnormality in the given scan, medical scans with similar patient history and/or similar risk factors, or some combination of these factors and/or other known and/or inferred factors. The similar abnormality data **1377** can be mapped to the medical scan to populate some or all of its corresponding similar scan data **480** for use by one or more other subsystems **101** and/or client devices **120**.

The similar scans identification step **1376** can include performing a scan similarity algorithm, which can include generating a feature vector for the given medical scan and for medical scans in the set of medical scans, where the feature vector can be generated based on quantitative and/or category based visual features, inferred features, abnormality location and/or characteristics such as the predetermined size and/or volume, patient history and/or risk factor features, or other known or inferred features. A medical scan similarity analysis function can be applied to the feature vector of the given medical scan and one or more feature vectors of medical scans in the set. The medical scan similarity analysis function can include computing a similarity distance such as the Euclidian distance between the feature vectors, and assigning the similarity distance to the corresponding medical scan in the set. Similar medical scans can be identified based on determining one or more medical scans in the set with a smallest computed similarity distance, based on ranking medical scans in the set based on the computed similarity distances and identifying a designated number of top ranked medical scans, and/or based on determining if a similarity distance between the given medical scan and a medical scan in the set is smaller than a similarity threshold. Similar medical scans can also be identified based on determining medical scans in a database

that mapped to a medical code that matches the medical code of the medical scan, or mapped to other matching classifying data. A set of identified similar medical scans can also be filtered based on other inputted or automatically generated criteria, where for example only medical scans with reliable diagnosis data or rich patient reports, medical scans with corresponding with longitudinal data in the patient file such as multiple subsequent scans taken at later dates, medical scans with patient data that corresponds to risk factors of the given patient, or other identified criteria, where only a subset of scans that compare favorably to the criteria are selected from the set and/or only a highest ranked single scan or subset of scans are selected from the set, where the ranking is automatically computed based on the criteria. Filtering the similar scans in this fashion can include calculating, or can be based on previously calculated, one or more scores as discussed herein. For example, the ranking can be based on a longitudinal quality score, such as the longitudinal quality score **434**, which can be calculated for an identified medical scan based on a number of subsequent and/or previous scans for the patient. Alternatively or in addition, the ranking can be based on a confidence score associated with diagnosis data of the scan, such as confidence score data **460**, based on performance score data associated with a user or medical entity associated with the scan, based on an amount of patient history data or data in the medical scan entry **352**, or other quality factors. The identified similar medical scans can be filtered based on ranking the scans based on their quality score and/or based on comparing their quality score to a quality score threshold. In some embodiments, a longitudinal threshold must be reached, and only scans that compare favorably to the longitudinal threshold will be selected. For example, only scans with at least three scans on file for the patient and final biopsy data will be included.

In some embodiments, the similarity algorithm can be utilized in addition to or instead of the trained abnormality classification function to determine some or all of the inferred classification data **1375** of the medical scan, based on the classification data such as abnormality classification data **445** or other diagnosis data **440** mapped to one or more of the identified similar scans. In other embodiments, the similarity algorithm is merely used to identify similar scans for review by medical professionals to aid in review, diagnosis, and/or generating medical reports for the medical image.

A display parameter step **1378** can be performed based on the detection and/or classification of the abnormality. The display parameter step can include generating display parameter data **1379**, which can include parameters that can be used by an interactive interface to best display each abnormality. The same or different display parameters can be generated for each abnormality. The display parameter data generated in the display parameter step **1378** can be mapped to the medical scan to populate some or all of its corresponding display parameter data **470** for use by one or more other subsystems **101** and/or client devices **120**.

Performing the display parameter step **1378** can include selecting one or more image slices that include the abnormality by determining the one or more image slices that include the abnormality and/or determining one or more image slices that has a most optimal two-dimensional view of the abnormality, for example by selecting the center slice in a set of consecutive slices that are determined to include the abnormality, selecting a slice that has the largest cross-section of the abnormality, selecting a slice that includes a two-dimensional image of the abnormality that is most similar to a selected most similar two-dimensional-image,

selecting the slice that was used as input to the abnormality classification step and/or similar scan identification step, or based on other criteria. This can also include automatically cropping one or more selected image slices based on an identified region that includes the abnormality. This can also select an ideal Hounsfield window that best displays the abnormality. This can also include selecting other display parameters based on data generated by the medical scan interface evaluating system and based on the medical scan.

FIGS. **8A-8F** illustrate embodiments of a medical picture archive integration system **2600**. The medical picture archive integration system **2600** can provide integration support for a medical picture archive system **2620**, such as a PACS that stores medical scans. The medical picture archive integration system **2600** can utilize model parameters received from a central server system **2640** via a network **2630** to perform an inference function on de-identified medical scans of medical scans received from the medical picture archive system **2620**. The annotation data produced by performing the inference function can be transmitted back to the medical picture archive system. Furthermore, the annotation data and/or de-identified medical scans can be sent to the central server system **2640**, and the central server system can train on this information to produce new and/or updated model parameters for transmission back to the medical picture archive integration system **2600** for use on subsequently received medical scans.

In various embodiments, medical picture archive integration system **2600** includes a de-identification system that includes a first memory designated for protected health information (PHI), operable to perform a de-identification function on a DICOM image, received from a medical picture archive system, to identify at least one patient identifier and generate a de-identified medical scan that does not include the at least one patient identifier. The medical picture archive integration system further includes a de-identified image storage system that stores the de-identified medical scan in a second memory that is separate from the first memory, and an annotating system, operable to utilize model parameters received from a central server to perform an inference function on the de-identified medical scan, retrieved from the second memory to generate annotation data for transmission to the medical picture archive system as an annotated DICOM file.

The first memory and the second memory can be implemented by utilizing separate storage systems: the first memory can be implemented by a first storage system designated for PHI storage, and the second memory can be implemented by a second storage system designated for storage of de-identified data. The first storage system can be protected from access by the annotating system, while the second storage system can be accessible by the annotating system. The medical picture archive integration system **2600** can be operable to perform the de-identification function on data in first storage system to generate de-identified data. The de-identified data can then be stored in the second storage system for access by the annotating system. The first and second storage systems can be physically separate, each utilizing at least one of their own, separate memory devices. Alternatively, the first and second storage systems can be virtually separate, where data is stored in separate virtual memory locations on the same set of memory devices. Firewalls, virtual machines, and/or other protected containerization can be utilized to enforce the separation of data in each storage system, to protect the first storage system from access by the annotating system and/or from other unauthorized access, and/or to ensure that only data of the first

storage system that has been properly de-identified through application of the de-identification function can be stored in the second storage system.

As shown in FIG. 8A, the medical picture archive system 2620 can receive image data from a plurality of modality machines 2622, such as CT machines, MRI machines, x-ray machines, and/or other medical imaging machines that produce medical scans. The medical picture archive system 2620 can store this image data in a DICOM image format and/or can store the image data in a plurality of medical scan entries 352 as described in conjunction with some or all of the attributes described in conjunction with FIGS. 4A and 4B. While “DICOM image” will be used herein to refer to medical scans stored by the medical picture archive system 2620, the medical picture archive integration system 2600 can provide integration support for medical picture archive systems 2620 that store medical scans in other formats.

The medical picture archive integration system 2600 can include a receiver 2602 and a transmitter 2604, operable to transmit and receive data from the medical picture archive system 2620, respectively. For example, the receiver 2602 and transmitter 2604 can be configured to receive and transmit data, respectively, in accordance with a DICOM communication protocol and/or another communication protocol recognized by the medical image archive system 2620. The receiver can receive DICOM images from the medical picture archive system 2620. The transmitter 2604 can send annotated DICOM files to the medical picture archive system 2620.

DICOM images received via receiver 2602 can be sent directly to a de-identification system 2608. The de-identification system 2608 can be operable to perform a de-identification function on the first DICOM image to identify at least one patient identifier in the DICOM image, and to generate a de-identified medical scan that does not include the identified at least one patient identifier. As used herein, a patient identifier can include any patient identifying data in the image data, header, and/or metadata of a medical scan, such as a patient ID number or other unique patient identifier, an accession number, a service-object pair (SOP) instance unique identifier (UID) field, scan date and/or time that can be used to determine the identity of the patient that was scanned at that date and/or time, and/or other private data corresponding to the patient, doctor, or hospital. In some embodiments, the de-identified medical scan is still in a DICOM image format. For example, a duplicate DICOM image that does not include the patient identifiers can be generated, and/or the original DICOM image can be altered such that the patient identifiers of the new DICOM image are masked, obfuscated, removed, replaced with a custom fiducial, and/or otherwise anonymized. In other embodiments, the de-identified medical scan is formatted in accordance with a different image format and/or different data format that does not include the identifying information. In some embodiments, other private information, for example, associated with a particular doctor or other medical professional, can be identified and anonymized as well.

Some patient identifying information can be included in a DICOM header of the DICOM image, for example, in designated fields for patient identifiers. These corresponding fields can be anonymized within the corresponding DICOM header field. Other patient identifying information can be included in the image itself, such as in medical scan image data 410. For example, the image data can include a patient name or other identifier that was handwritten on a hard copy of the image before the image was digitized. As another example, a hospital administered armband or other visual

patient information in the vicinity of the patient may have been captured in the image itself. A computer vision model can detect the presence of these identifiers for anonymization, for example, where a new DICOM image includes a fiducial image that covers the identifying portion of the original DICOM image. In some embodiments, patient information identified in the DICOM header can be utilized to detect corresponding patient information in the image itself. For example, a patient name extracted from the DICOM header before anonymization can be used to search for the patient name in the image and/or to detect a location of the image that includes the patient name. In some embodiments, the de-identification system 2608 is implemented by the de-identification system discussed in conjunction with FIGS. 10A, 10B and 11, and/or utilizes functions and/or operations discussed in conjunction with FIGS. 10A, 10B and 11.

The de-identified medical scan can be stored in de-identified image storage system 2610 and the annotating system 2612 can access the de-identified medical scan from the de-identified image storage system 2610 for processing. The de-identified storage system can archive a plurality of de-identified DICOM images and/or can serve as temporary storage for the de-identified medical scan until processing of the de-identified medical scan by the annotating system 2612 is complete. The annotating system 2612 can generate annotation data by performing an inference function on the de-identified medical scan, utilizing the model parameters received from the central server system 2640. The annotation data can correspond to some or all of the diagnosis data 440 as discussed in conjunction with FIGS. 4A and 4B. In some embodiments, the annotating system 2612 can utilize the model parameters to perform inference step 1354, the detection step 1372, the abnormality classification step 1374, the similar scan identification step 1376, and/or the display parameter step 1378 of the medical scan image analysis system 112, as discussed in conjunction with FIG. 7B, on de-identified medical scans received from the medical picture archive system 2620.

In some embodiments, model parameters for a plurality of inference functions can be received from the central server system 2640, for example, where each inference function corresponds to one of a set of different scan categories. Each scan category can correspond to a unique combination of one or a plurality of scan modalities, one of a plurality of anatomical regions, and/or other scan classifier data 420. For example, a first inference function can be trained on and intended for de-identified medical scans corresponding chest CT scans, and a second inference function can be trained on and intended for de-identified medical scans corresponding to head MRI scans. The annotating system can select one of the set of inference functions based on determining the scan category of the DICOM image, indicated in the de-identified medical scan, and selecting the inference function that corresponds to the determined scan category.

To ensure that scans received from the medical picture archive system 2620 match the set of scan categories for which the annotating system is operable to perform a corresponding inference function, the transmitter can transmit requests, such as DICOM queries, indicating image type parameters such as parameters corresponding to scan classifier data 420, for example indicating one or more scan modalities, one or more anatomical regions, and/or other parameters. For example, the request can indicate that all incoming scans that match the set of scan categories corresponding to a set of inference functions the annotating

system **2612** for which the annotating system has obtained model parameters from the central server system **2640** and is operable to perform.

Once the annotation data is generated by performing the selected inference function, the annotating system **2612** can generate an annotated DICOM file for transmission to the medical image archive system **2620** for storage. The annotated DICOM file can include some or all of the fields of the diagnosis data **440** and/or abnormality annotation data **442** of FIGS. **4A** and **4B**. The annotated DICOM file can include scan overlay data, providing location data of an identified abnormality and/or display data that can be used in conjunction with the original DICOM image to indicate the abnormality visually in the DICOM image and/or to otherwise visually present the annotation data, for example, for use with the medical scan assisted review system **102**. For example, a DICOM presentation state file can be generated to indicate the location of an abnormality identified in the de-identified medical scan. The DICOM presentation state file can include an identifier of the original DICOM image, for example, in metadata of the DICOM presentation state file, to link the annotation data to the original DICOM image. In other embodiments, a full, duplicate DICOM image is generated that includes the annotation data with an identifier linking this duplicate annotated DICOM image to the original DICOM image.

The identifier linking the annotated DICOM file to the original DICOM image can be extracted from the original DICOM file by the de-identification system **2608**, thus enabling the medical picture archive system **2620** to link the annotated DICOM file to the original DICOM image in its storage. For example, the de-identified medical scan can include an identifier that links the de-identified medical scan to the original DICOM file, but does not link the de-identified medical scan to a patient identifier or other private data.

In some embodiments, generating the annotated DICOM file includes altering one or more fields of the original DICOM header. For example, standardized header formatting function parameters can be received from the central server system and can be utilized by the annotating system to alter the original DICOM header to match a standardized DICOM header format. The standardized header formatting function can be trained in a similar fashion to other medical scan analysis functions discussed herein and/or can be characterized by some or all fields of a medical scan analysis function entry **356**. The annotating system can perform the standardized header formatting function on a de-identified medical scan to generate a new, standardized DICOM header for the medical scan to be sent back to the medical picture archive system **2620** in the annotated DICOM file and/or to replace the header of the original DICOM file. The standardized header formatting function can be run in addition to other inference functions utilized to generate annotation data. In other embodiments, the medical picture archive integration system **2600** is implemented primarily for header standardization for medical scans stored by the medical picture archive system **2620**. In such embodiments, only the standardized header formatting function is performed on the de-identified data to generate a modified DICOM header for the original DICOM image, but the de-identified medical scan is not annotated.

In some embodiments of header standardization, the annotation system can store a set of acceptable, standardized entries for some or all of the DICOM header fields, and can select one of the set of acceptable, standardized entries in populating one or more fields of the new DICOM header for

the annotated DICOM file. For example, each of the set of scan categories determined by the annotating system can correspond to a standardized entry of one or more fields of the DICOM header. The new DICOM header can thus be populated based on the determined scan category.

In some embodiments, each of the set of standardized entries can be mapped to a set of related, non-standardized entries, such as entries in a different order, commonly misspelled entries, or other similar entries that do not follow a standardized format. For example, one of the set of acceptable, standardized entries for a field corresponding to a scan category can include "Chest CT", which can be mapped to a set of similar, non-standardized entries which can include "CT chest", "computerized topography CT", and/or other entries that are not standardized. In such embodiments, the annotating system can determine the original DICOM header is one of the similar non-standardized entries, and can select the mapped, standardized entry as the entry for the modified DICOM header. In other embodiments, the image data itself and/or other header data can be utilized by the annotation system to determine a standardized field. For example, an input quality assurance function **1106** can be trained by the central server system and sent to the annotating system to determine one or more appropriate scan classifier fields, or one or more other DICOM header fields, based on the image data or other data of the de-identified medical scan. One or more standardized labels can be assigned to corresponding fields of the modified DICOM header based on the one or more fields determined by the input quality assurance function.

In some embodiments, the DICOM header is modified based on the annotation data generated in performing the inference function. In particular, a DICOM priority header field can be generated and/or modified automatically based on the severity and/or time-sensitivity of the abnormalities detected in performing the inference function. For example, a DICOM priority header field can be changed from a low priority to a high priority in response to annotation data indicating a brain bleed in the de-identified medical scan of a DICOM image corresponding to a head CT scan, and a new DICOM header that includes the high priority DICOM priority header field can be sent back to the medical picture archive system **2620** to replace or otherwise be mapped to the original DICOM image of the head CT scan.

In various embodiments, the medical picture archive system **2620** is disconnected from network **2630**, for example, to comply with requirements regarding Protected Health Information (PHI), such as patient identifiers and other private patient information included in the DICOM images and/or otherwise stored by the medical picture archive system **2620**. The medical picture archive integration system **2600** can enable processing of DICOM images while still protecting private patient information by first de-identifying DICOM data by utilizing de-identification system **2608**. The de-identification system **2608** can utilize designated processors and memory of the medical picture archive integration system, for example, designated for PHI. The de-identification system **2608** can be decoupled from the network **2630** to prevent the DICOM images that still include patient identifiers from being accessed via the network **2630**. For example, as shown in FIG. **8A**, the de-identification system **2608** is not connected to network interface **2606**. Furthermore, only the de-identification system **2608** has access to the original DICOM files received from the medical picture archive system **2620** via receiver **2602**. The de-identified image storage system **2610** and annotating system **2612**, as they are connected to network

2630 via network interface 2606, only store and have access to the de-identified medical scan produced by the de-identification system 2608.

This containerization that separates the de-identification system 2608 from the de-identified image storage system 2610 and the annotating system 2612 is further illustrated in FIG. 8B, which presents an embodiment of the medical picture archive integration system 2600. The de-identification system 2608 can include its own designated memory 2654 and processing system 2652, connected to receiver 2602 via bus 2659. For example, this memory 2654 and processing system 2652 can be designated for PHI, and can adhere to requirements for handling PHI. The memory 2654 can store executable instructions that, when executed by the processing system 2652, enable the de-identification system to perform the de-identification function on DICOM images received via receiver 2602 of the de-identification system. The incoming DICOM images can be temporarily stored in memory 2654 for processing, and patient identifiers detected in performing the de-identification function can be temporarily stored in memory 2654 to undergo anonymization. Interface 2655 can transmit the de-identified medical scan to interface 2661 for use by the de-identified image storage system 2610 and the annotating system 2612. Interface 2655 can be protected from transmitting original DICOM files and can be designated for transmission of de-identified medical scan only.

Bus 2669 connects interface 2661, as well as transmitter 2604 and network interface 2606, to the de-identified image storage system 2610 and the annotating system 2612. The de-identified image storage system 2610 and annotating system 2612 can utilize separate processors and memory, or can utilize shared processors and/or memory. For example, the de-identified image storage system 2610 can serve as temporary memory of the annotating system 2612 as de-identified images are received and processed to generate annotation data.

As depicted in FIG. 8B, the de-identified image storage system 2610 can include memory 2674 that can temporarily store incoming de-identified medical scans as it undergoes processing by the annotating system 2612 and/or can archive a plurality of de-identified medical scans corresponding to a plurality of DICOM images received by the medical picture archive integration system 2600. The annotating system 2612 can include a memory 2684 that stores executable instructions that, when executed by processing system 2682, cause the annotating system 2612 perform a first inference function on de-identified medical scan to generate annotation data by utilizing the model parameters received via interface 2606, and to generate an annotated DICOM file based on the annotation data for transmission via transmitter 2604. The model parameters can be stored in memory 2684, and can include model parameters for a plurality of inference functions, for example, corresponding to a set of different scan categories.

The medical picture archive integration system can be an onsite system, installed at a first geographic site, such as a hospital or other medical entity that is affiliated with the medical picture archive system 2620. The hospital or other medical entity can further be responsible for the PHI of the de-identification system, for example, where the memory 2654 and processing system 2652 are owned by, maintained by, and/or otherwise affiliated with the hospital or other medical entity. The central server system 2640 can be located at a second, separate geographic site that is not affiliated with the hospital or other medical entity and/or at a separate geographic site that is not affiliated with the

medical picture archive system 2620. The central server system 2640 can be a server configured to be outside the network firewall and/or out outside the physical security of the hospital or other medical entity or otherwise not covered by the particular administrative, physical and technical safeguards of the hospital or other medical entity.

FIG. 8C further illustrates how model parameters can be updated over time to improve existing inference functions and/or to add new inference functions, for example corresponding to new scan categories. In particular, the some or all of the de-identified medical scans generated by the de-identification system 2608 can be transmitted back to the central server system, and the central server system 2640 can train on this data to improve existing models by producing updated model parameters of an existing inference function and/or to generate new models, for example, corresponding to new scan categories, by producing new model parameters for new inference functions. For example, the central server system 2640 can produce updated and/or new model parameters by performing the training step 1352 of the medical scan image analysis system 112, as discussed in conjunction with FIG. 7A, on a plurality of de-identified medical scans received from the medical picture archive integration system 2600.

The image type parameters can be determined by the central server system to dictate characteristics of the set of de-identified medical scans to be received to train and/or retrain the model. For example, the image type parameters can correspond to one or more scan categories, can indicate scan classifier data 420, can indicate one or more scan modalities, one or more anatomical regions, a date range, and/or other parameters. The image type parameters can be determined by the central server system based on training parameters 620 determined for the corresponding inference function to be trained, and/or based on characteristics of a new and/or existing scan category corresponding to the inference function to be trained. The image type parameters can be sent to the medical picture archive integration system 2600, and a request such as a DICOM query can be sent to the medical picture archive system 2620, via transmitter 2604, that indicates the image type parameters. For example, the processing system 2682 can be utilized to generate the DICOM query based on the image type parameters received from the central server system 2640. The medical picture archive system can automatically transmit one or more DICOM images to the medical picture archive integration system in response to determining that the one or more DICOM images compares favorably to the image type parameters. The DICOM images received in response can be de-identified by the de-identification system 2608. In some embodiments, the de-identified medical scans can be transmitted directly to the central server system 2640, for example, without generating annotation data.

The central server system can generate the new and/or updated model parameters by training on the received set of de-identified medical scans, and can transmit the new and/or updated model parameters to the de-identified storage system. If the model parameters correspond to a new inference function for a new scan category, the medical picture archive integration system 2600 can generate a request, such as a DICOM query, for transmission to the medical picture archive system indicating that incoming scans corresponding to image type parameters corresponding to the new scan category be sent to the medical picture archive integration system. The annotating system can update the set of inference functions to include the new inference function, and the annotating system can select the new inference function

from the set of inference functions for subsequently generated de-identified medical scans by the de-identification system by determining each of these de-identified medical scans indicate the corresponding DICOM image corresponds to the new scan category. The new model parameters can be utilized to perform the new inference function on each of these de-identified medical scans to generate corresponding annotation data, and an annotated DICOM file corresponding to each of these de-identified medical scans can be generated for transmission to the medical picture archive system via the transmitter.

In some embodiments, the central server system **2640** receives a plurality of de-identified medical scans from a plurality of medical picture archive integration system **2600**, for example, each installed at a plurality of different hospitals or other medical entities, via the network **2630**. The central server system can generate training sets by integrating de-identified medical scans from some or all of the plurality of medical picture archive integration systems **2600** to train one or more inference functions and generate model parameters. The plurality of medical picture archive integration systems **2600** can utilize the same set of inference functions or different sets of inference functions. In some embodiments, the set of inference functions utilized by the each of the plurality of medical picture archive systems **2620** are trained on different sets of training data. For example, the different sets of training data can correspond to the set of de-identified medical scans received from the corresponding medical picture archive integration system **2600**.

In some embodiments, the medical scan diagnosing system **108** can be utilized to implement the annotating system **2612**, where the corresponding subsystem processing device **235** and subsystem memory device **245** of the medical scan diagnosing system **108** are utilized to implement the processing system **2682** and the memory **2684**, respectively. Rather than receiving the medical scans via the network **150** as discussed in conjunction with FIG. **6A**, the medical scan diagnosing system **108** can perform a selected medical scan inference function **1105** on an incoming de-identified medical scan generated by the de-identification system **2608** and/or retrieved from the de-identified image storage system **2610**. Memory **2684** can store the set of medical scan inference functions **1105**, each corresponding to a scan category **1120**, where the inference function is selected from the set based on determining the scan category of the de-identified medical scan and selecting the corresponding inference function. The processing system **2682** can perform the selected inference function **1105** to generate the inference data **1110**, which can be further utilized by the annotating system **2612** to generate the annotated DICOM file for transmission back to the medical picture archive system **2620**. New medical scan inference functions **1105** can be added to the set when corresponding model parameters are received from the central server system. The remediation step **1140** can be performed locally by the annotating system **2612** and/or can be performed by the central server system **2640** by utilizing one or more de-identified medical scans and corresponding annotation data sent to the central server system **2640**. Updated model parameters can be generated by the central server system **2640** and sent to the medical picture archive integration system **2600** as a result of performing the remediation step **1140**.

The central server system **2640** can be implemented by utilizing one or more of the medical scan subsystems **101**, such as the medical scan image analysis system **112** and/or the medical scan diagnosing system **108**, to produce model parameters for one or more inference functions. The central

server system can store or otherwise communicate with a medical scan database **342** that includes the de-identified medical scans and/or annotation data received from one or more medical picture archive integration systems **2600**.

Some or all entries of the medical scan database **342** can be utilized to as training data to produce model parameters for one or more inference functions. These entries of the medical scan database **342** can be utilized by other subsystems **101** as discussed herein. For example, other subsystems **101** can utilize the central server system **2640** to fetch medical scans and/or corresponding annotation data that meet specified criteria. The central server system **2640** can query the medical picture archive integration system **2600** based on this criteria, and can receive de-identified medical scans and/or annotation data in response. This can be sent to the requesting subsystem **101** directly and/or can be added to the medical scan database **342** or another database of the database storage system **140** for access by the requesting subsystem **101**.

Alternatively or in addition, the central server system **2640** can store or otherwise communicate with a user database **344** storing user profile entries corresponding to each of a plurality of medical entities that each utilize a corresponding one of a plurality of medical picture archive integration systems **2600**. For example, basic user data corresponding to the medical entity can be stored as basic user data, a number of scans or other consumption information indicating usage of one or more inference functions by corresponding medical picture archive integration system can be stored as consumption usage data, and/or a number of scans or other contribution information indicating de-identified scans sent to the central server system as training data can be stored as contribution usage data. The user profile entry can also include inference function data, for example, with a list of model parameters or function identifiers, such as medical scan analysis function identifiers **357**, of inference functions currently utilized by the corresponding medical picture archive integration system **2600**. These entries of the user database **344** can be utilized by other subsystems **101** as discussed herein.

Alternatively or in addition, the central server system **2640** can store or otherwise communicate with a medical scan analysis function database **346** to store model parameters, training data, or other information for one or more inference functions as medical scan analysis function entries **356**. In some embodiments, model parameter data **623** can indicate the model parameters and function classifier data **610** can indicate the scan category of inference function entries. In some embodiments, the medical scan analysis function entry **356** can further include usage identifying information indicating a medical picture archive integration system identifier, medical entity identifier, and/or otherwise indicating which medical archive integration systems and/or medical entities have received the corresponding model parameters to utilize the inference function corresponding to the medical scan analysis function entry **356**. These entries of the medical scan analysis function database **346** can be utilized by other subsystems **101** as discussed herein.

In some embodiments, the de-identification function is a medical scan analysis function, for example, with a corresponding medical scan analysis function entry **356** in the medical scan analysis function database **346**. In some embodiments, the de-identification function is trained by the central server system **2640**. For example, the central server system **2640** can send de-identification function parameters to the medical picture archive integration system **2600** for use by the de-identification system **2608**. In embodiments

with a plurality of medical picture archive integration systems **2600**, each of the plurality of medical picture archive integration systems **2600** can utilize the same or different de-identification functions. In some embodiments, the de-identification function utilized by the each of the plurality of medical picture archive integration systems **2600** are trained on different sets of training data. For example, the different sets of training data can correspond to each different set of de-identified medical scans received from each corresponding medical picture archive integration system **2600**.

In some embodiments, as illustrated in FIGS. **8D-8F**, the medical picture archive integration system **2600** can further communicate with a report database **2625**, such as a Radiology Information System (RIS), that includes a plurality of medical reports corresponding to the DICOM images stored by the medical picture archive system **2620**.

As shown in FIG. **8D**, the medical picture archive integration system **2600** can further include a receiver **2603** that receives report data, corresponding to the DICOM image, from report database **2625**. The report database **2625** can be affiliated with the medical picture archive system **2620** and can store report data corresponding to DICOM images stored in the medical picture archive system. The report data of report database **2625** can include PHI, and the report database **2625** can thus be disconnected from network **2630**.

The report data can include natural language text, for example, generated by a radiologist that reviewed the corresponding DICOM image. The report data can be used to generate the de-identified medical scan, for example, where the de-identification system **2608** performs a natural language analysis function on the report data to identify patient identifying text in the report data. The de-identification system **2608** can utilize this patient identifying text to detect matching patient identifiers in the DICOM image to identify the patient identifiers of the DICOM image and generate the de-identified medical scan. In some embodiments, the report data can be de-identified by obfuscating, hashing, removing, replacing with a fiducial, or otherwise anonymizing the identified patient identifying text to generate de-identified report data.

The de-identified report data can be utilized by the annotating system **2612**, for example, in conjunction with the DICOM image, to generate the annotation data. For example, the annotating system **2612** can perform a natural language analysis function on the de-identified natural language text of the report data to generate some or all of the annotation data. In some embodiments, the de-identified report data is sent to the central server system, for example, to be used as training data for inference functions, for natural language analysis functions, for other medical scan analysis functions, and/or for use by at least one other subsystem **101**. For example, other subsystems **101** can utilize the central server system **2640** to fetch medical reports that correspond to particular medical scans or otherwise meet specified criteria. The central server system **2640** can query the medical picture archive integration system **2600** based on this criteria, and can receive de-identified medical reports in response. This can be sent to the requesting subsystem **101** directly, can be added to the medical scan database **342**, a de-identified report database, or another database of the database storage system **140** for access by the requesting subsystem **10**.

In some embodiments the medical picture archive integration system **2600** can query the report database **2625** for the report data corresponding to a received DICOM image by utilizing a common identifier extracted from the DICOM image.

In some embodiments, the report data can correspond to a plurality of DICOM images. For example, the report data can include natural language text describing a plurality of medical scans of a patient that can include multiple sequences, multiple modalities, and/or multiple medical scans taken over time. In such embodiments, the patient identifying text and/or annotation data detected in the report data can also be applied to de-identify and/or generate annotation data for the plurality of DICOM images it describes. In such embodiments, the medical picture archive integration system **2600** can query the medical picture archive system **2620** for one or more additional DICOM images corresponding to the report data, and de-identified data and annotation data for these additional DICOM images can be generated accordingly by utilizing the report data.

In some embodiments, as shown in FIG. **8E**, the medical picture archive system **2620** communicates with the report database **2625**. The medical picture archive system **2620** can request the report data corresponding to the DICOM image from the report database **2625**, and can transmit the report data to the medical picture archive integration system **2600** via a DICOM communication protocol for receipt via receiver **2602**. The medical picture archive system **2620** can query the report database **2625** for the report data, utilizing a common identifier extracted from the corresponding DICOM image, in response to determining to send the corresponding DICOM image to the medical picture archive integration system **2600**.

FIG. **8F** presents an embodiment where report data is generated by the annotating system **2612** and is transmitted, via a transmitter **2605**, to the report database **2625**, for example via a DICOM communication protocol or other protocol recognized by the report database **2625**. In other embodiments, the report data is instead transmitted via transmitter **2604** to the medical picture archive system **2620**, and the medical picture archive system **2620** transmits the report data to the report database **2625**.

The report data can be generated by the annotating system **2612** as output of performing the inference function on the de-identified medical scan. The report data can include natural language text data **448** generated automatically based on other diagnosis data **440** such as abnormality annotation data **442** determined by performing the inference function, for example, by utilizing a medical scan natural language generating function trained by the medical scan natural language analysis system **114**. The report data can be generated instead of, or in addition to, the annotated DICOM file.

FIG. **9** presents a flowchart illustrating a method for execution by a medical picture archive integration system **2600** that includes a first memory and a second memory that store executional instructions that, when executed by at least one first processor and at least one second processor, respectfully, cause the medical picture archive integration system to perform the steps below. In various embodiments, the first memory and at least one first processor are implemented by utilizing, respectfully, the memory **2654** and processing system **2652** of FIG. **8B**. In various embodiments, the second memory is implemented by utilizing the memory **2674** and/or the memory **2684** of FIG. **8B**. In various embodiments, the at least one second processor is implemented by utilizing the processing system **2682** of FIG. **8B**.

Step **2702** includes receiving, from a medical picture archive system via a receiver, a first DICOM image for storage in the first memory, designated for PHI, where the first DICOM image includes at least one patient identifier.

Step 2704 includes performing, via at least one first processor coupled to the first memory and designated for PHI, a de-identification function on the first DICOM image to identify the at least one patient identifier and generate a first de-identified medical scan that does not include the at least one patient identifier.

Step 2706 includes storing the first de-identified medical scan in a second memory that is separate from the first memory. Step 2708 includes receiving, via a network interface communicating with a network that does not include the medical picture archive system, first model parameters from a central server.

Step 2710 includes retrieving the first de-identified medical scan from the second memory. Step 2712 includes utilizing the first model parameters to perform a first inference function on the first de-identified medical scan to generate first annotation data via at least one second processor that is different from the at least one first processor. Step 2714 includes generating, via the at least one second processor, a first annotated DICOM file for transmission to the medical picture archive system via a transmitter, where the first annotated DICOM file includes the first annotation data and further includes an identifier that indicates the first DICOM image. In various embodiments, the first annotated DICOM file is a DICOM presentation state file.

In various embodiments, the second memory further includes operational instructions that, when executed by the at least one second processor, further cause the medical picture archive integration system to retrieve a second de-identified medical scan from the de-identified image storage system, where the second de-identified medical scan was generated by the at least one first processor by performing the de-identification function on a second DICOM image received from the medical picture archive system. The updated model parameters are utilized to perform the first inference function on the second de-identified medical scan to generate second annotation data. A second annotated DICOM file is generated for transmission to the medical picture archive system via the transmitter, where the second annotated DICOM file includes the second annotation data and further includes an identifier that indicates the second DICOM image.

In various embodiments, the second memory stores a plurality of de-identified medical scans generated by the at least one first processor by performing the de-identification function on a corresponding plurality of DICOM images received from the medical picture archive system via the receiver. The plurality of de-identified medical scans is transmitted to the central server via the network interface, and the central server generates the first model parameters by performing a training function on training data that includes the plurality of de-identified medical scans.

In various embodiments, the central server generates the first model parameters by performing a training function on training data that includes a plurality of de-identified medical scans received from a plurality of medical picture archive integration systems via the network. Each of the plurality of medical picture archive integration systems communicates bidirectionally with a corresponding one of a plurality of medical picture archive systems, and the plurality of de-identified medical scans corresponds to a plurality of DICOM images stored by the plurality of medical picture archive integration systems.

In various embodiments, the first de-identified medical scan indicates a scan category of the first DICOM image. The second memory further stores operational instructions that, when executed by the at least one second processor,

further cause the medical picture archive integration system to select the first inference function from a set of inference functions based on the scan category. The set of inference functions corresponds to a set of unique scan categories that includes the scan category. In various embodiments, each unique scan category of the set of unique scan categories is characterized by one of a plurality of modalities and one of a plurality of anatomical regions.

In various embodiments, the first memory further stores operational instructions that, when executed by the at least one first processor, further cause the medical picture archive integration system to receive a plurality of DICOM image data from the medical picture archive system via the receiver for storage in the first memory in response to a query transmitted to the medical picture archive system via the transmitter. The query is generated by the medical picture archive integration system in response to a request indicating a new scan category received from the central server via the network. The new scan category is not included in the set of unique scan categories, and the plurality of DICOM image data corresponds to the new scan category. The de-identification function is performed on the plurality of DICOM image data to generate a plurality of de-identified medical scans for transmission to the central server via the network.

The second memory further stores operational instructions that, when executed by the at least one second processor, further cause the medical picture archive integration system to receive second model parameters from the central server via the network for a new inference function corresponding to the new scan category. The set of inference functions is updated to include the new inference function. The second de-identified medical scan is retrieved from the first memory, where the second de-identified medical scan was generated by the at least one first processor by performing the de-identification function on a second DICOM image received from the medical picture archive system. The new inference function is selected from the set of inference functions by determining the second de-identified medical scan indicates the second DICOM image corresponds to the new scan category. The second model parameters are utilized to perform the new inference function on the second de-identified medical scan to generate second annotation data. A second annotated DICOM file is generated for transmission to the medical picture archive system via the transmitter, where the second annotated DICOM file includes the second annotation data and further includes an identifier that indicates the second DICOM image.

In various embodiments, the medical picture archive integration system generates parameter data for transmission to the medical picture archive system that indicates the set of unique scan categories. The medical picture archive system automatically transmits the first DICOM image to the medical picture archive integration system in response to determining that the first DICOM image compares favorably to one of the set of unique scan categories.

In various embodiments, the second memory further stores operational instructions that, when executed by the at least one second processor, cause the medical picture archive integration system to generate a natural language report data is based on the first annotation data and to transmit, via a second transmitter, the natural language report data to a report database associated with the medical picture archive integration system, where the natural language report data includes an identifier corresponding to the first DICOM image.

In various embodiments, the first memory further stores operational instructions that, when executed by the at least one first processor, cause the medical picture archive integration system to receive, via a second receiver, a natural language report corresponding to the first DICOM image from the report database. A set of patient identifying text included in the natural language report are identified. Performing the de-identification function on the first DICOM image includes searching the first DICOM image for the set of patient identifying text to identify the at least one patient identifier.

In various embodiments, the first memory is managed by a medical entity associated with the medical picture archive system. The medical picture archive integration system is located at a first geographic site corresponding to the medical entity, and the central server is located at a second geographic site. In various embodiments, the first memory is decoupled from the network to prevent the first DICOM image that includes the at least one patient identifier from being communicated via the network. In various embodiments, the medical picture archive system is a Picture Archive and Communication System (PACS) server, and the first DICOM image is received in response to a query sent to the medical picture archive system by the transmitter in accordance with a DICOM communication protocol.

FIG. 10A presents an embodiment of a de-identification system 2800. The de-identification system 2800 can be utilized to implement the de-identification system 2608 of FIGS. 8A-8F. In some embodiments, the de-identification system 2800 can be utilized by other subsystems to de-identify image data, medical report data, private fields of medical scan entries 352 such as patient identifier data 431, and/or other private fields stored in databases of the database memory device 340.

The de-identification system can be operable to receive, from at least one first entity, a medical scan and a medical report corresponding to the medical scan. A set of patient identifiers can be identified in a subset of fields of a header of the medical scan. A header anonymization function can be performed on each of the set of patient identifiers to generate a corresponding set of anonymized fields. A de-identified medical scan can be generated by replacing the subset of fields of the header of the medical scan with the corresponding set of anonymized fields.

A subset of patient identifiers of the set of patient identifiers can be identified in the medical report by searching text of the medical report for the set of patient identifiers. A text anonymization function can be performed on the subset of patient identifiers to generate corresponding anonymized placeholder text for each of the subset of patient identifiers. A de-identified medical report can be generated by replacing each of the subset of patient identifiers with the corresponding anonymized placeholder text. The de-identified medical scan and the de-identified medical report can be transmitted to a second entity via a network.

As shown in FIG. 10A, the de-identification system 2800 can include at least one receiver 2802 operable to receive medical scans, such as medical scans in a DICOM image format. The at least one receiver 2802 is further operable to receive medical reports, such as report data 449 or other reports containing natural language text diagnosing, describing, or otherwise associated the medical scans received by the de-identification system. The medical scans and report data can be received from the same or different entity, and can be received by the same or different receiver 2802 in accordance with the same or different communication protocol. For example, the medical scans can be received from

the medical picture archive system 2620 of FIGS. 8A-8F and the report data can be received from the report database 2625 of FIGS. 8D-8F. In such embodiments, the receiver 2802 can be utilized to implement the receiver 2602 of FIG. 8B.

The de-identification system 2800 can further include a processing system 2804 that includes at least one processor, and a memory 2806. The memory 2806 can store operational instructions that, when executed by the processing system, cause the de-identification system to perform at least one patient identifier detection function on the received medical scan and/or the medical report to identify a set of patient identifiers in the medical scan and/or the medical report. The operational instructions, when executed by the processing system, can further cause the de-identification system to perform an anonymization function on the medical scan and/or the medical report to generate a de-identified medical scan and/or a de-identified medical report that do not include the set of patient identifiers found in performing the at least one patient identifier detection function. Generating the de-identified medical scan can include generating a de-identified header and generating de-identified image data, where the de-identified medical scan includes both the de-identified header and the de-identified image data. The memory 2806 can be isolated from Internet connectivity, and can be designated for PHI.

The de-identification system 2800 can further include at least one transmitter 2808, operable to transmit the de-identified medical scan and de-identified medical report. The de-identified medical scan and de-identified medical report can be transmitted back to the same entity from which they were received, respectively, and/or can be transmitted to a separate entity. For example, the at least one transmitter can transmit the de-identified medical scan to the de-identified image storage system 2610 of FIGS. 8A-8F and/or can transmit the de-identified medical scan to central server system 2640 via network 2630 of FIGS. 8A-8F. In such embodiments, the transmitter 2808 can be utilized to implement the interface 2655 of FIG. 8B. The receiver 2802, processing system 2804, memory 2806, and/or transmitter 2808 can be connected via bus 2810.

Some or all of the at least one patient identifier detection function and/or at least one anonymization function as discussed herein can be trained and/or implemented by one or subsystems 101 in the same fashion as other medical scan analysis functions discussed herein, can be stored in medical scan analysis function database 346 of FIG. 3, and/or can otherwise be characterized by some or all fields of a medical scan analysis function entry 356 of FIG. 5.

The de-identification system 2800 can perform separate patient identifier detection functions on the header of a medical report and/or medical scan, on the text data of the medical report, and/or on the image data of the medical scan, such as text extracted from the image data of the medical scan. Performance of each of these functions generates an output of its own set of identified patient identifiers. Combining these sets of patient identifiers yields a blacklist term set. A second pass of the header of a medical report and/or medical scan, on the text data of the medical report, and/or on the image data of the medical scan that utilizes this blacklist term set can catch any terms that were missed by the respective patient identifier detection function, and thus, the outputs of these multiple identification processes can support each other. For example, some of the data in the headers will be in a structured form and can thus be easier to reliably identify. This can be exploited and used to further anonymize these identifiers when they appear in free text header fields, report data, and/or in the image data of the

medical scan. Meanwhile, unstructured text in free text header fields, report data, and/or image data of the medical scan likely includes pertinent clinical information to be preserved in the anonymization process, for example, so it can be leveraged by at least one subsystems **101** and/or so it can be leveraged in training at least one medical scan analysis function.

At least one first patient identifier detection function can include extracting the data in a subset of fields of a DICOM header, or another header or other metadata of the medical scan and/or medical report with a known type that corresponds to patient identifying data. For example, this patient identifying subset of fields can include a name field, a patient ID number field or other unique patient identifier field, a date field, a time field, an age field, an accession number field, SOP instance UID, and/or other fields that could be utilized to identify the patient and/or contain private information. A non-identifying subset of fields of the header can include hospital identifiers, machine model identifiers, and/or some or all fields of medical scan entry **352** that do not correspond to patient identifying data. The patient identifying subset of fields and the non-identifying subset of fields can be mutually exclusive and collectively exhaustive with respect to the header. The at least one patient identifier function can include generating a first set of patient identifiers by ignoring the non-identifying subset of fields and extracting the entries of the patient identifying subset of fields only. This first set of patient identifiers can be anonymized to generate a de-identified header as discussed herein.

In some embodiments, at least one second patient identifier detection function can be performed on the report data of the medical report. The at least one second patient identifier detection function can include identifying patient identifying text in the report data by performing a natural language analysis function, for example, trained by the medical scan natural language analysis system **114**. For example, the at least one second patient identifier detection function can leverage the known structure of the medical report and/or context of the medical report. A second set of patient identifiers corresponding to the patient identifying text can be determined, and the second set of patient identifiers can be anonymized to generate a de-identified medical report. In some embodiments, a de-identified medical report includes clinical information, for example, because the portion of the original medical report that includes the clinical information was deemed to be free of patient identifying text and/or because the portion of the original medical report that includes the clinical information was determined to include pertinent information to be preserved.

In some embodiments, the medical report includes image data corresponding to freehand or typed text. For example the medical report can correspond to a digitized scan of original freehand text written by a radiologist or other medical professional. In such embodiments, the patient identifier detection function can first extract the text from the freehand text in the image data to generate text data before the at least one second patient identifier detection function is performed on the text of the medical report to generate the second set of patient identifiers.

In some embodiments, the at least one second patient identifier detection function can similarly be utilized to identify patient identifying text in free text fields and/or unstructured text fields of a DICOM header and/or other metadata of the medical scan and/or medical report data by performing a natural language analysis function, for

example, trained by the medical scan natural language analysis system **114**. A third set of patient identifiers corresponding to this patient identifying text of the free text and/or unstructured header fields can be determined, and the third set of patient identifiers can be anonymized to generate de-identified free text header field and/or unstructured header fields. In some embodiments, a de-identified free text header field and/or unstructured header field includes clinical information, for example, because the portion of the original corresponding header field that includes the clinical information was deemed to be free of patient identifying text and/or because the portion of the original corresponding header field that includes the clinical information was determined to include pertinent information to be preserved.

Patient identifiers can also be included in the image data of the medical scan itself. For example, freehand text corresponding to a patient name written on a hard copy of the medical scan before digitizing can be included in the image data, as discussed in conjunction with FIG. **10B**. Other patient identifiers, such as information included on a patient wristband or other identifying information located on or within the vicinity of the patient may have been captured when the medical scan was taken, and can thus be included in the image. At least one third patient identifier detection function can include extracting text from the image data and/or detecting non-text identifiers in the image data by performing a medical scan image analysis function, for example, trained by the medical scan image analysis system **112**. For example, detected text that corresponds to an image location known to include patient identifiers, detected text that corresponds to a format of a patient identifier, and/or or detected text or other image data determined to correspond to a patient identifier can be identified. The at least one third patient identifier detection function can further include identifying patient identifying text in the text extracted from the image data by performing the at least one second patient identifier detection function and/or by performing a natural language analysis function. A fourth set of patient identifiers corresponding to patient identifying text or other patient identifiers detected in the image data of the medical scan can be determined, and the fourth set of patient identifiers can be anonymized in the image data to generate de-identified image data of the medical scan as described herein. In particular, the fourth set of patient identifiers can be detected in a set of regions of image data of the medical scan, and the set of regions of the image data can be anonymized.

In some embodiments, only a subset of the patient identifier detection functions described herein are performed to generate respective sets of patient identifiers for anonymization. In some embodiments, additional patient identifier detection functions can be performed on the medical scan and/or medical report to determine additional respective sets of patient identifiers for anonymization. The sets of patient identifiers outputted by performing each patient identifier detection function can have a null or non-null intersection. The sets of patient identifiers outputted by performing each patient identifier function can have null or non-null set differences.

Cases where the sets of patient identifiers have non-null set differences can indicate that a patient identifier detected by one function may have been missed by another function. The combined set of patient identifiers, for example, generated as the union of the sets of sets of patient identifiers outputted by performing each patient identifier function, can be used to build a blacklist term set, for example, stored in memory **2806**. The blacklist term set can designate the final set of terms to be anonymized. A second pass of header data,

medical scans, medical reports, and/or any free text extracted from the header data, the medical scan, and/or the medical report can be performed by utilizing the blacklist term set to flag terms for anonymization that were not caught in performing the respective at least one patient identifier detection function. For example, performing the second pass can include identifying at least one patient identifier of the blacklist term set in the header, medical report, and/or image data of the medical scan. This can include by searching corresponding extracted text of the header, medical report, and/or image data for terms included in blacklist term set and/or by determining if each term in the extracted text is included in the blacklist term set.

In some embodiments, at least one patient identifier is not detected until the second pass is performed. Consider an example where a free text field of a DICOM header included a patient name that was not detected in performing a respective patient identifier detection function on the free text field of the DICOM header. However, the patient name was successfully identified in the text of the medical report in performing a patient identifier detection function on the medical report. This patient name is added to the blacklist term list, and is detected in a second pass of the free text field of the DICOM header. In response to detection in the second pass, the patient name of the free text field of the DICOM header can be anonymized accordingly to generate a de-identified free text field. Consider a further example where the patient name is included in the image data of the medical scan, but was not detected in performing a respective patient identifier detection function on the free text field of the DICOM header. In the second pass, this patient name can be detected in at least one region of image data of the medical scan by searching the image data for the blacklist term set.

In some embodiments, performing some or all of the patient identifier detection functions includes identifying a set of non-identifying terms, such as the non-identifying subset of fields of the header. In particular, the non-identifying terms can include terms identified as clinical information and/or other terms determined to be preserved. The combined set of non-identifying terms, for example, generated as the union of the sets of sets of non-identifying outputted by performing each patient identifier function, can be used to build a whitelist term set, for example, stored in memory **2806**. Performing the second pass can further include identifying at least one non-identifying term of the whitelist term set in the header, medical report, and/or image data of the medical scan, and determining not to anonymize, or to otherwise ignore, the non-identifying term.

In various embodiments, some or all terms of the whitelist term set can be removed from the blacklist term set. In particular, at least one term previously identified as a patient identifier in performing one or more patient identifier detection functions is determined to be ignored and not anonymized in response to determining the term is included in the whitelist term set. This can help ensure that clinically important information is not anonymized, and is thus preserved in the de-identified medical scan and de-identified medical report.

In some embodiments, the second pass can be performed after each of the patient identifier detection functions are performed. For example, performing the anonymization function can include performing this second pass by utilizing the blacklist term set to determine the final set of terms to be anonymized. New portions of text in header fields, not previously detected in generating the first set of patient identifiers or the third set of patient identifiers, can be flagged for anonymization by determining these new por-

tions of text correspond to terms of the blacklist term set. New portions of text the medical report, not previously detected in generating in the second set of patient identifiers, can be flagged for anonymization by determining these new portions of text correspond to terms of the blacklist term set. New regions of the image data of the medical scan, not previously detected in generating the fourth set of patient identifiers, can be flagged for anonymization by determining these new portions of text correspond to terms of the blacklist term set.

In some embodiments, the blacklist term set is built as each patient identifier detection function is performed, and performance of subsequent patient identifier detection functions includes utilizing the current blacklist term set. For example, performing the second patient identifier detection function can include identifying a first subset of the blacklist term set in the medical report by searching the text of the medical report for the blacklist term set and/or by determining if each term in the text of the medical report is included in the blacklist term set. Performing the second patient identifier detection function can further include identifying at least one term in the medical report that is included in the whitelist term set, and determining to ignore the term in response. The first subset can be anonymized to generate the de-identified medical report as discussed herein. New patient identifiers not already found can be appended to the blacklist term set, and the updated blacklist term set can be applied to perform a second search of the header and/or image data of the medical scan, and at least one of the new patient identifiers can be identified in the header in the second search of the header and/or in the image data in a second search of the image data. These newly identified patient identifiers in the header and/or image data are anonymized in generating the de-identified medical scan.

As another example, a second subset of the blacklist term set can be detected in a set of regions of image data of the medical scan by performing the medical scan image analysis function on image data of the medical scan, where the image analysis function includes searching the image data for the set of patient identifiers. For example, the medical scan image analysis function can include searching the image data for text, and the second subset can include detected text that matches one or more terms of the blacklist term set. In some embodiments, detected text that matches one or more terms of the whitelist term set can be ignored. The second subset can be anonymized to generate de-identified image data as discussed herein. New patient identifiers that are detected can be appended to the blacklist term set, and the updated blacklist term set can be applied to perform a second search of the header and/or metadata of the medical scan, and/or can be applied to perform a second search of the medical report. At least one of the new patient identifiers can be identified in the header as a result of performing the second search of the header and/or at least one of the new patient identifiers can be identified medical report as a result of performing the second search of the medical report. These newly identified patient identifiers can be anonymized in the header along with the originally identified blacklist term set in generating the de-identified header, and/or can be anonymized in the medical report along with the originally identified first subset in generating the de-identified medical report.

In some embodiments, the memory **2806** further stores a global blacklist, for example, that includes a vast set of known patient identifying terms. In some embodiments, the global blacklist is also utilized by at least one patient identifier detection function and/or in performing the second

pass to determine patient identifying terms for anonymization. In some embodiments, the blacklist term set generated for a particular medical scan and corresponding medical report can be appended to the global blacklist for use in performing the second pass and/or in detecting patient identifiers in subsequently received medical scans and/or medical reports.

Alternatively or in addition, the memory **2806** can further store a global whitelist, for example, that includes a vast set of terms that can be ignored. In particular, the global whitelist can include clinical terms and/or other terms that are deemed beneficial to preserve that do not correspond to patient identifying information. In some embodiments, the global whitelist is utilized by at least one patient identifier detection function and/or in performing the second pass to determine terms to ignore in the header, image data, and/or medical report. In some embodiments, the whitelist term set generated for a particular medical scan and corresponding medical report can be appended to the global whitelist for use in performing the second pass and/or in ignoring terms in subsequently received medical scans and/or medical reports.

Alternatively or in addition, the memory **2806** can further store a global graylist, for example, that includes ambiguous terms that could be patient identifying terms in some contexts, but non-identifying terms in other contexts. For example, "Parkinson" could correspond to patient identifying data if part of a patient name such as "John Parkinson", but could correspond to non-patient identifying data meant to be ignored and preserved in the de-identified medical report and/or de-identified medical scan if part of a diagnosis term such as "Parkinson's disease." In some embodiments, the global graylist is also utilized in performing the second pass and/or in performing at least one patient identifier detection function to determine that a term is included in the graylist, and to further determine whether the term should be added to the blacklist term set for anonymization or whitelist term set to be ignored by leveraging context of accompanying text, by leveraging known data types of a header field from which the term was extracted, by leveraging known structure of the term, by leveraging known data types of a location of the image data from which the term was extracted, and/or by leveraging other contextual information. In some embodiments, the graylist term set can be updated based on blacklist and/or whitelist term sets for a particular medical scan and corresponding medical report.

In some embodiments, the at least one anonymization function includes a fiducial replacement function. For example, some or all of the blacklist term set can be replaced with a corresponding, global fiducial in the header, report data, and/or image data. In some embodiments, the global fiducial can be selected from a set of global fiducials based on a type of the corresponding patient identifier. Each patient identifier detected in the header and/or medical report can be replaced with a corresponding one of the set of global text fiducials. Each patient identifiers detected in the image data can be replaced with a corresponding one of the set of global image fiducials. For example, one or more global image fiducials can overlay pixels of regions of the image data that include the identifying patient data, to obfuscate the identifying patient data in the de-identified image data.

The global text fiducials and/or global image fiducials can be recognizable by inference functions and/or training functions, for example, where the global text fiducials and global image fiducials are ignored when processed in a training step to train an inference function and/or are ignored in an inference step when processed by an inference function.

Furthermore, the global text fiducials and/or global image fiducials can be recognizable by a human viewing the header, medical report, and/or image data. For example, a radiologist or other medical professional, upon viewing a header, medical report, and/or image data, can clearly identify the location of a patient identifier that was replaced by the fiducial and/or can identify the type of patient identifier that was replaced by the fiducial.

As an example, the name "John Smith" can be replaced in a header and/or medical report with the text "% PATIENT NAME %", where the text "% PATIENT NAME %" is a global fiducial for name types of the header and/or the text of medical reports. The training step and/or inference step of medical scan natural language analysis functions can recognize and ignore text that matches "% PATIENT NAME %" automatically.

FIG. **10B** illustrates an example of anonymizing patient identifiers in image data of a medical scan. In this example, the name "John Smith" and the date "May 4, 2010" is detected as freehand text in the original image data of a medical scan. The regions of the image data that include the patient identifiers can each be replaced by global fiducial in the shape of a rectangular bar, or any other shape. As shown in FIG. **10B**, a first region corresponding to the location of "John Smith" in the original image data is replaced by fiducial **2820** in the de-identified image data, and a second region corresponding to the location of "May 4, 2010" in the original image data is replaced by fiducial **2822** in the de-identified image data. The size, shape, and/or location of each global visual fiducial can be automatically determined based on the size, shape, and/or location of the region that includes the patient identifier to minimize the amount of the image data that is obfuscated, while still ensuring the entirety of the text is covered. While not depicted in FIG. **10B**, the fiducial can be of a particular color, for example, where pixels of the particular color are automatically recognized by the training step and/or inference step of medical scan image analysis functions to indicate that the corresponding region be ignored, and/or where the particular color is not included in the original medical scan and/or is known to not be included in any medical scans. The fiducial can include text recognizable to human inspection such as "% PATIENT NAME" and "% DATE" as depicted in FIG. **10B**, and/or can include a QR code, logo, or other unique symbol recognizable to human inspection and/or automatically recognizable by the training step and/or inference step of medical scan image analysis functions to indicate that the corresponding region be ignored.

In some embodiments, other anonymization functions can be performed on different ones of the patient identifying subset of fields to generate the de-identified header, de-identified report data, and/or de-identified image data. For example, based on the type of identifying data of each field of the header, different types of header anonymization functions and/or text anonymization functions can be selected and utilized on the header fields, text of the report, and/or text extracted from the image data. A set of anonymization functions can include a shift function, for example, utilized to offset a date, time or other temporal data by a determined amount to preserve absolute time difference and/or to preserve relative order over multiple medical scans and/or medical reports of a single patient. FIG. **10B** depicts an example where the shift function is performed on the date detected in the image data to generate fiducial **2822**, where the determined amount is 10 years and 1 month. The determined amount can be determined by the de-identification system randomly and/or pseudo-randomly for each

patient and/or for each medical scan and corresponding medical report, ensuring the original date cannot be recovered by utilizing a known offset. In various embodiments, other medical scans and/or medical reports are fetched for the same patient by utilizing a patient ID number or other unique patient identifier of the header. These medical scans and reports can be anonymized as well, where the dates and/or times detected in these medical scans and/or medical reports offset by the same determined amount, randomized or pseudo-randomized for particular patient ID number, for example, based on performing a hash function on the patient ID number.

The set of anonymization functions can include at least one hash function, for example utilized to hash a unique patient ID such as a patient ID number, accession number, and/or SOP instance UID of the header and/or text. In some embodiments, the hashed SOP instance UID, accession number, and/or patient ID number are prepended with a unique identifier, stored in a database of the memory 2806 and/or shared with the entities to which the de-identified medical scans and/or medical reports are transmitted, so that de-identified medical scans and their corresponding de-identified medical reports can be linked and retrieved retroactively. Similarly, longitudinal data can be preserved as multiple medical scans and/or medical reports of the same patient will be assigned the same hashed patient ID.

The set of anonymization functions can further include at least one manipulator function for some types of patient identifiers. Some values of header fields and/or report text that would normally not be considered private information can be considered identifying patient data if they correspond to an outlier value or other rare value that could then be utilized to identify the corresponding patient from a very small subset of possible options. For example, a patient age over 89 could be utilized to determine the identity of the patient, for example, if there are very few patients over the age of 89. To prevent such cases, in response to determining that a patient identifier corresponds to an outlier value and/or in response to determining that a patient identifier compares unfavorably to a normal-range threshold value, the patient identifier can be capped at the normal-range threshold value or can otherwise be manipulated. For example, a normal-range threshold value corresponding to age can be set at 89, and generating a de-identified patient age can include capping patient ages that are higher than 89 at 89 and/or can include keeping the same value for patient ages that are less than or equal to 89.

In some embodiments, the de-identified header data is utilized to replace the corresponding first subset of patient identifiers detected in the medical report with text of the de-identified header fields. In other embodiments, a set of text anonymization functions includes a global text fiducial replacement function, shift function, a hash function, and/or manipulator functions that anonymize the corresponding types of patient identifiers in the medical report separately.

In some embodiments where the image data of a medical scan includes an anatomical region corresponding to a patient's head, the image data may include an identifying facial structure and/or facial features that could be utilized to determine the patient's identity. For example, a database of facial images, mapped to a corresponding plurality of people including the patient, could be searched and a facial recognition function could be utilized to identify the patient in the database. Thus, facial structure included in the image data can be considered patient identifying data.

To prevent this problem and maintain patient privacy, the de-identification system can further be implemented to per-

form facial obfuscation for facial structure detected in medical scans. At least one region of the image data that includes identifying facial structure can be determined by utilizing a medical image analysis function. For example, the medical image analysis function can include a facial detection function that determines the regions of the image data that include identifying facial structure based on searching the image data for pixels with a density value that corresponds to facial skin, facial bone structure, or other density of an anatomical mass type that corresponds to identifying facial structure, and the facial obfuscation function can be performed on the identified pixels. Alternatively or in addition, the facial detection function can determine the region based on identifying at least one shape in the image data that corresponds to a facial structure.

The image obfuscation function can include a facial structure obfuscation function performed on the medical scan to generate de-identified image data that does not include identifying facial structure. For example, the facial structure obfuscation function can mask, scramble, replace with a fiducial, or otherwise obfuscate the pixels of the region identified by the facial detection function. In some embodiments, the facial structure obfuscation function can perform a one-way function on the region that preserves abnormalities of the corresponding portions of the image, such as nose fractures or facial skin lesions, while still obfuscating the identifying facial structure such that the patient is not identifiable. For example, the pixels of the identifying facial structure can be altered such that they converge towards a fixed, generic facial structure. In some embodiments, a plurality of facial structure image data of a plurality of patients can be utilized to generate the generic facial structure, for example, corresponding to an average or other combination of the plurality of faces. For example, the pixels of the generic facial structure can be averaged with, superimposed upon, or otherwise combined with the pixels of the region of the image data identified by the facial detection function in generating the de-identified image data.

In some embodiments, a hash function can be performed on an average of the generic facial structure and the identified facial structure of the image data so that the generic facial structure cannot be utilized in conjunction with the resulting data of the de-identified image data to reproduce the original, identifying facial structure. In such embodiments, the hash function can alter the pixel values while still preserving abnormalities. In some embodiments, a plurality of random, generic facial structures can be generated by utilizing the plurality of facial structure image data, for example, where each if the plurality of facial structure image data are assigned a random or pseudo-random weight in an averaging function utilized to create the generic facial structure, where a new, random or pseudo-random set of weights are generated each time the facial structure obfuscation function is utilized to create a new, generic facial structure to be averaged with the identified facial structure in creating the de-identified image data to ensure the original identifying facial structure cannot be extracted from the resulting de-identified image data.

While facial obfuscation is described herein, similar techniques can be applied in a similar fashion to other anatomical regions that are determined to include patient identifiers and/or to other anatomical regions that can be utilized to extract patient identifying information if not anonymized.

In some embodiments, the at least one receiver 2802 is included in at least one transceiver, for example, enabling bidirectional communication between the medical picture

61

archive system **2620** and/or the report database **2625**. In such embodiments, the de-identification system **2800** can generate queries to the medical picture archive system **2620** and/or the report database **2625** for particular medical scans and/or medical reports, respectively. In particular, if the medical scan and medical report are stored and/or managed by separate memories and/or separate entities, they may not be received at the same time. However, a linking identifier, such as DICOM identifiers in headers or metadata of the medical scan and/or medical report, such as accession number, patient ID number, SOP instance UID, or other linking identifier that maps the medical scan to the medical report can be utilized to fetch a medical report corresponding to a received medical scan and/or to fetch a medical scan corresponding to a received medical report via a query sent utilizing the at least one transceiver. For example, in response to receiving the medical scan from the medical picture archive system **2620**, the de-identification system can extract a linking identifier from a DICOM header of the medical scan, and can query the report database **2625** for the corresponding medical report by indicating the linking identifier in the query. Conversely, in response to receiving the medical report from the report database **2625**, the de-identification system can extract the linking identifier from a header, metadata, and/or text body of the medical report, and can query the medical picture archive system **2620** for the corresponding medical scan by indicating the linking identifier in the query. In some embodiments, a mapping of de-identified medical scans to original medical scans, and/or a mapping of de-identified medical reports to original medical reports can be stored in memory **2806**. In some embodiments, linking identifiers such as patient ID numbers can be utilized to fetch additional medical scans, additional medical reports, or other longitudinal data corresponding to the same patient.

FIG. **11** presents a flowchart illustrating a method for execution by a de-identification system **2800** that stores executional instructions that, when executed by at least one processor, cause the de-identification to perform the steps below.

Step **2902** includes receiving from a first entity, via a receiver, a first medical scan and a medical report corresponding to the medical scan. Step **2904** includes identifying a set of patient identifiers in a subset of fields of a first header of the first medical scan. Step **2906** includes performing a header anonymization function on each of the set of patient identifiers to generate a corresponding set of anonymized fields. Step **2908** includes generating a first de-identified medical scan by replacing the subset of fields of the first header of the first medical scan with the corresponding set of anonymized fields. Step **2910** includes identifying a first subset of patient identifiers of the set of patient identifiers in the medical report by searching text of the medical report for the set of patient identifiers. Step **2912** includes performing a text anonymization function on the first subset of patient identifiers to generate corresponding anonymized placeholder text for each of the first subset of patient identifiers. Step **2914** includes generating a de-identified medical report by replacing each of the first subset of patient identifiers with the corresponding anonymized placeholder text. Step **2916** includes transmitting, via a transmitter, the de-identified first medical scan and the de-identified medical report to a second entity via a network.

In various embodiments, the medical scan is received from a Picture Archive and Communication System (PACS), wherein the medical report is received from a Radiology Information System (RIS), and wherein the first de-identi-

62

fied medical scan and the de-identified medical report are transmitted to a central server that is not affiliated with the PACS or the RIS. In various embodiments, first medical scan and the medical report are stored in a first memory for processing. The first memory is decoupled from the network to prevent the set of patient identifiers from being communicated via the network. The first de-identified medical scan and the de-identified medical report are stored in a second memory that is separate from the first memory. The first de-identified medical scan and the de-identified medical report are fetched from the second memory for transmission to the second entity.

In various embodiments, the header anonymization function performed on each of the set of patient identifiers is selected from a plurality of header anonymization functions based on one of a plurality of identifier types of the corresponding one of the subset of fields. In various embodiments, the plurality of identifier types includes a date type. A shift function corresponding to the date type is performed on a first date of the first header to generate the first de-identified medical scan, where the shift function includes offsetting the first date by a determined amount. A second medical scan is received, via the receiver, that includes a second header. A unique patient ID of the first header matches a unique patient ID of the second header. The shift function is performed on a second date of the second header by offsetting the second date by the determined amount to generate a second de-identified medical scan. The second de-identified medical scan is transmitted to the second entity via the network.

In various embodiments, the plurality of identifier types includes a unique patient ID type. A hash function corresponding to the unique patient ID type is performed on the unique patient ID of the first header to generate the first de-identified medical scan. The hash function is performed on the unique patient ID of the second header to generate the second de-identified medical scan. An anonymized unique patient ID field of the first de-identified medical scan matches an anonymized unique patient ID field of the second de-identified medical scan as a result of the unique patient ID of the first header matching the unique patient ID of the second header.

In various embodiments, the plurality of identifier types includes a linking identifier type that maps the medical scan to the medical report. A hash function corresponding to the linking identifier type is performed on a linking identifier of the first header to generate a hashed linking identifier. A linking identifier field of the first de-identified medical scan includes the hashed linking identifier. Performing the text anonymization function on the first subset of patient identifiers includes determining one of the first subset of patient identifiers corresponds to linking identifier text and performing the hash function on the one of the first subset of patient identifiers to generate the hashed linking identifier, where the de-identified medical report includes the hashed linking identifier.

In various embodiments, a second subset of patient identifiers of the set of patient identifiers is identified in a set of regions of image data of the medical scan by performing an image analysis function on image data of the medical scan. The image analysis function includes searching the image data for the set of patient identifiers. An identifier type is determined for each of the second subset of patient identifiers. One of a plurality of image fiducials is selected for each of the second subset of patient identifiers based on the identifier type. De-identified image data is generated, where a set of regions of the de-identified image data, correspond-

ing to the set of regions of the image data, includes the one of the plurality of image fiducials to obfuscate each of the second subset of patient identifiers. Generating the first de-identified medical scan further includes replacing the image data of the medical scan with the de-identified image data.

In various embodiments, a new patient identifier is identified in the medical report by performing a natural language analysis function on the medical report, where new patient identifier is not included in the set of patient identifiers. The set of patient identifiers is updated to include the new patient identifier prior to searching the image data of the medical scan for the set of patient identifiers, and the second subset of patient identifiers includes the new patient identifier.

In various embodiments, the memory further stores a global identifier blacklist. The natural language analysis function includes searching the medical report for a plurality of terms included in the global identifier blacklist to identify the new patient identifier. In various embodiments, the de-identification system determines that the global identifier blacklist does not include one of the set of patient identifiers, and the global identifier blacklist is updated to include the one of the set of patient identifiers.

In various embodiments, performing the image analysis function further includes identifying a new patient identifier in the image data, where new patient identifier is not included in the set of patient identifiers. Identifying text is extracted from a region of the image data corresponding to the new patient identifier. The new patient identifier is identified in the medical report by searching text of the medical report for the identifying text. The text anonymization function is performed on new patient identifier to generate anonymized placeholder text for the new patient identifier. Generating the de-identified medical report further includes replacing the identifying text with the anonymized placeholder text for the new patient identifier.

In various embodiments, generating the de-identified image data further includes detecting an identifying facial structure in the image data of the medical scan. Generating the de-identified image data includes performing a facial structure obfuscation function on the image data, and wherein the de-identified image data does not include the identifying facial structure.

FIG. 12A is a schematic block diagram of a medical scan viewing system in accordance with various embodiments. In particular, a medical scan viewing system 3100 is presented that can be used in conjunction with a medical picture archive system 2620, a medical scan database 342 and/or other medical scan database to retrieve a medical scan 3120 for review by a user.

In various embodiments, the medical picture archive system 2620 can receive image data from a plurality of modality machines 2622, such as CT machines, MRI machines, x-ray machines, and/or other medical imaging machines that produce medical scans 3120. The medical scans 3120 can include imaging data corresponding to a CT scan, x-ray, MRI, PET scan, Ultrasound, EEG, mammogram, or other type of radiological scan or medical scan taken of an anatomical region of a human body, animal, or other organism and further can include metadata corresponding to the imaging data. The medical picture archive system 2620, such as a PACS or other database can store these medical scans 3120 in a DICOM image format or other medical scan image data 410 and/or can store the image data in a plurality of medical scan entries 352 as described in conjunction with some or all of the attributes described in conjunction with FIGS. 4A and 4B.

In various embodiments, the medical scan viewing system 3100 includes a client device, such as client device 120 or other computer that operates as a PACS viewer or other interactive viewing system that aids the user, such as a radiologist or other medical professional, in the preparation of report data 3122 stored in the report database 2625 and/or an annotated medical scan 3123 stored in medical picture archive system 2620 for the purposes of medical triage, diagnosis, administrative evaluation, audit, and/or training. The medical scan viewing system 3100 can include functions and features previously described in conjunction with the medical scan assisted review system 102, medical scan report labeling system 104, medical scan annotator system 106, medical scan diagnosing system 108, medical scan interface feature evaluator system 110, medical scan image analysis system 112, medical scan natural language analysis system 114, and/or medical scan comparison system 116 first introduced in FIG. 1. The medical scan viewing system 3100 includes annotating system 2612 and operates, for example, as a multi-label generating system to automatically produce inference data from one or more inference functions for given medical scan 3120 utilizing computer vision techniques, natural language processing or other artificial intelligence (AI) models. This automatically generated inference data can be used to assist the user in generating and/or updating the report data 3122 and/or the annotated medical scan 3123. In operation, the inference data indicates a presence of one or more abnormalities when an inference function detects the presence of these abnormalities. The inference data indicates the absence of an abnormality when an inference function fails to detect the presence of that abnormality. While the annotating system 2612 is shown in FIG. 8B as having its own processing system 2682, the operation of processing system 3106 can be combined with processing system 2682 and operate via a single processing module or other platform.

The annotated medical scan 3123 can be an annotated DICOM file or annotated medical image data in some other format. The annotated DICOM file can include some or all of the fields of the diagnosis data 440 and/or abnormality annotation data 442 of FIGS. 4A and 4B and/or other report data and annotations. The annotated DICOM file can include scan overlay data, providing location data of an identified abnormality and/or display data that can be used in conjunction with the original DICOM image to indicate the abnormality visually in the DICOM image and/or to otherwise visually present the annotation data, for example, for use with the medical scan assisted review system 102. For example, a DICOM presentation state file can be generated to indicate the location of an abnormality identified in the de-identified medical scan. The DICOM presentation state file can include an identifier of the original DICOM image, for example, in metadata of the DICOM presentation state file, to link the annotation data to the original DICOM image. In other embodiments, a full, duplicate DICOM image is generated that includes the annotation data with an identifier linking this duplicate annotated DICOM image to the original DICOM image.

The report data 3122 can be formatted as text and optionally include other media and can include, for example diagnosis data 440, abnormality data 440, patient history data 430, diagnosis author data 450, scan classifier data 420, confidence score data 460 as described in conjunctions with FIGS. 4A and 4B, and/or other report data. The report database 2625, such as a Radiology Information System (RIS) or other database, stores the report data 3122 as a

plurality of medical reports corresponding to the medical scans **3120** stored by the medical picture archive system **2620**.

The medical scan viewing system **3100** includes a network interface **3102**, a processing system **3106** that includes a processor, a memory device **3104** a display device **3108** such as a touch screen or other display device and an interactive interface **3110** such as a microphone, speakers, mouse, touchpad, thumb wheel, joy stick, one or more buttons and/or other devices that allow a user to interact with the medical scan viewing system **3100**. In operation, the memory device **3104** stores executable instructions that, when executed by the processing system **3106**, configure the processor to perform various operations of the medical scan reviewing system **3100**, including, for example:

providing an interactive user interface, such as interactive interface **3110**, that facilitates selection of a medical scan **3120** for review;

facilitating retrieval of the medical scan **3120** from the medical picture archive system **2620** via the network interface **3102**;

facilitating, via the interactive user interface, display of the medical scan **3120** on the display device **3108** for review by the user;

facilitating, via the interactive user interface, the generation and collection of report data **3122** and/or annotated medical scan **3123**;

facilitating transmission of the report data **3122** to the report database **2625** via the network interface **3102**; and/or

facilitating transmission of the annotated medical scan **3123** to the medical picture archive system **2620** via the network interface **3102**.

In various embodiments, the medical scan viewing system **3100** utilizes training data with a large number of scans with global labels and a relatively small number of scans with regional labels, such as pixel-by-pixel or other fine-grained labels, grid square-by-grid square labels, a three-dimensional subregion **1310** label as discussed in conjunction with FIG. 7A and/or other non-global labels. The region labels are used to train one or more AI models, such as K inference functions that generate heat maps on a pixel-by-pixel basis, grid square-by-grid square basis or other non-global basis based on probability matrix output.

In various embodiments, the medical scan viewing system **3100** operates to:

store a first plurality of medical scans with corresponding global labels and a second plurality of medical scans with corresponding region labels, wherein the global labels each correspond to one of a set of abnormality classes and wherein each of the region labels correspond to one of the set of abnormality classes;

generate a computer vision model by training on the first plurality of medical scans with the corresponding global labels and the second plurality of medical scans with the corresponding region labels;

receive, via a receiver, a new medical scan;

generate global probability data based on the computer vision model, wherein the global probability data indicates a set of global probability values corresponding to the set of abnormality classes, and wherein each of the set of global probability values indicates a probability that a corresponding one of the set of abnormality classes is present in the new medical scan; and

transmit, via a transmitter, the global probability data to a client device for display via a display device.

For example, the global probability data can be generated based on probability matrix data generated by performing an inference function that utilizes the computer vision model on the new medical scan, wherein the probability matrix data includes, for each of a set of image patches of the new medical scan, a set of patch probability values corresponding to the set of abnormality classes, and wherein each of the set of patch probability values indicates a probability that a corresponding one of the set of abnormality classes is present in the each of the set of image patches.

In various embodiments, the number of medical scans in the first plurality of medical scans is greater than a number of medical scans in the second plurality of medical scans by a factor of 2, 5, 10, 20 or some other factor. For example, the training set can include a large number (e.g. 100K) scans with global labels only, and a small number (e.g. 10K) scans with pixel-by-pixel or other fine-grained labels. This combination improves the technology of medical scan viewing and annotating systems because it improves model accuracy compared with training only 10K scans even with their fine-grained labels, and improves training efficiency by not requiring fine-grained labeling of the additional 100K scans.

In particular, each region label indicates the presence of one of the K abnormalities within (or substantially within) that corresponding region of a medical scan. The region labels can correspond to pixel-by-pixel labels, where each pixel in a medical scan is labeled as corresponding to either the presence of a particular abnormality or the absence of abnormalities. In this case, the pixels themselves operate as individual regions with corresponding labels. Other, less fine-grained labels can be employed including three-dimensional subregion labels, a set of one or more grid squares corresponding to regions, regions bounded by polygons, ellipsoids or other shapes that define a region or other regions of interest containing an abnormality in each of a plurality of medical scans, with other portions of these medical scans being defined as not containing an abnormality.

For some of the K abnormality classes, the use of only global labels may suffice. In this case, the medical scans with region labels can correspond to only a subset of the set of the K abnormality classes. As it can be time-consuming to label the presence and/or absence of some or all of the modeled abnormalities (e.g. Pneumothorax) in a medical scan on a region basis, a global label indicating whether one or more the K abnormalities are present anywhere in the scan can be utilized instead. However, the use of a small number of examples with region labels can nevertheless be used to supplement the training set and lead to better generation of global probabilities and/or heat map visualization data.

In some cases, there is “noise” in the collected labels used for training the AI models. Some labels are wrong, but most represent ground truth. In various embodiments, the operational instructions, when executed by the at least one processor, further cause the global multi-label generating system to:

generate testing global probability data by performing an inference function that utilizes the computer vision model on the first plurality of medical scans with the corresponding global labels, wherein the testing global probability data indicates a testing set of global probability values corresponding to the set of abnormality classes, and wherein each of the testing set of global probability values indicates a probability that a corresponding one of the set of abnormality classes is present in each of the first plurality of medical scans with the corresponding global labels;

67

compare the testing set of global probability values to a corresponding confidence threshold for each of the first plurality of medical scans selected based on the corresponding one of the global labels;

generate an updated training data set by correcting ones of the first plurality of medical scans having a corresponding one of the testing set of global probability values that compares unfavorably to the corresponding confidence threshold; and

retrain the computer vision model on the updated training set.

Consider an example where a first version of the model can be trained using the original labels in the training set. The medical scan viewing system 3100 can operate to correct for noise in original training set by applying the first iteration of a trained model to the training set to generate model output for each scan in the training set. Errors in the labels of the initial training set can be determined by the model itself. For example, errors in some subset of the medical scans in the training set can be determined by identifying the medical scans with model output that indicates an output classification with very high confidence that disagrees with the label corresponding to a scan. If the model output indicates a global confidence lower than 0.05, for example, that a particular abnormality is present—indicating the abnormality is determined with high confidence to be absent—while the label for the scan indicates the opposite, that the abnormality is present, the model is expected to be “correct” in these highly confident cases, indicating that the original label was incorrect. Further, if the model output indicates a global confidence greater than 0.95, for example, that a particular abnormality is present—indicating the abnormality is determined with high confidence to be present—while the label for the scan indicates the opposite, that the abnormality is absent, the model can also be deemed correct, given the high confidence. In either case, the label error in the training set can be corrected/updated by either flipping the label for the medical scan in the training set to match the model output or by omitting the corresponding medical scan from the training set. The updated training set can be used retrain the AI model. This process can be repeated several times until no errors are detected, otherwise as necessary and/or as new training data is added.

Consider further the following formalization. Let (x_i, y_i) be the i th input-target pair from the training set $D = \{(x_i, y_i), 1 \leq i \leq N\}$, and assume there are an unknown number of corrupted labels in D . A randomly sampled mini-batch $B = \{(x_i, y_i), 1 \leq i \leq M\}$ consists of samples with clean labels y^* and noisy labels y^\diamond , where $N \gg M$. Standard gradient-based training updates to model parameters θ at step t can be generated by

$$\theta_{t+1} = \theta_t - \alpha \nabla \left(\frac{1}{|M^*|} \sum_{(x,y) \in M^*} \mathcal{L}(x, y; \theta_t) + \frac{1}{|M^\diamond|} \sum_{(x,y) \in M^\diamond} \mathcal{L}(x, y; \theta_t) \right) \quad (1)$$

where α is the learning rate, \mathcal{L} is the loss function, M^* is the clean subset of training pairs, and M^\diamond is the incorrectly-labelled subset. The presence of noisy labels in the mini-batch results in incorrect gradients with which the model parameters are updated. This phenomenon is observed through the entire course of training, potentially leading to a sub-optimal optimization process. Different choices of loss

68

function $L(x, y; \theta_t)$ from Eq. (1) exhibit different level of robustness to the labeling noise. The most general form of L is focal loss for classification

$$F_L(p_c) = -(1 - p_c)^\gamma \log(p_c) \quad (2)$$

where p_c is the probability of the prediction belonging to class c . It is a direct generalization of the standard cross entropy loss when setting $\gamma=0$. While the focal loss can be quite useful in learning hard or rare examples, it makes a strong assumption regarding the quality of labels. In the presence of noisy labels in the dataset, easy examples with corrupted labels often end up with high training costs due to the discrepancy between high prediction probabilities and the wrong labels. This results in the focal loss inadvertently up-weighting noisy examples. This negatively impacts the optimization of the model learning during training, leading to overfitting and poor generalization.

In order to study the effects of noisy label on focal loss, consider the focal loss of a single example with a noisy label to be F_L as shown in Eq. (2). Further, by replacing p_t by $1-p_t$, the focal loss can be obtained of the same example but with respect to the corrected label as shown in Eq. (3) below

$$F^*_L(p_c) = -(p_c)^\gamma \log(1-p_c) \quad (3)$$

Now, let ψ denote the logarithm of the ratio between the focal loss with corrected label and the focal loss with the original corrupted label, as shown in Eq. (4) below:

$$\Psi = \log \left(\left(\frac{1-p_c}{p_c} \right)^\gamma * \frac{\log(p_c)}{\log(1-p_c)} \right) \quad (4)$$

A robust loss implies

$$F_L(p_c) = F^*_L(p_c)$$

which results in $\psi=0$ at $p_c=0.5$. Examples that a model considers as highly confident are assigned to the group of either $p_c \rightarrow 0$ and $p_c \rightarrow 1$. The behavior of ψ can be analyzed in both scenarios:

$$\begin{aligned} \lim_{p_c \rightarrow 0} \Psi &= \lim_{p_c \rightarrow 0} \log \left(\left(\frac{1-p_c}{p_c} \right)^\gamma \frac{\log(p_c)}{\log(1-p_c)} \right) \\ &= \lim_{p_c \rightarrow 0} \left(\log \left(\frac{1-p_c}{p_c} \right)^\gamma + \log \frac{-\log(p_c)}{-\log(1-p_c)} \right) \\ &= \underbrace{\lim_{p_c \rightarrow 0} \left(\gamma \log \frac{1-p_c}{p_c} \right)}_A + \underbrace{\lim_{p_c \rightarrow 0} (\log(-\log p_c))}_B \\ &= \underbrace{\lim_{p_c \rightarrow 0} -(\log(-\log(1-p_c)))}_C \end{aligned}$$

It is easy to see that when $p_c \rightarrow 0$, $A=+\infty$, $B=+\infty$, $C=+\infty$, therefore $\lim_{p_c \rightarrow 0} \Psi = +\infty$. Similarly, when $p_c \rightarrow 1$, $A=-\infty$, $B=-\infty$, $C=-\infty$, therefore $\lim_{p_c \rightarrow 1} \Psi = -\infty$. This property implies that a high confidence prediction paired with a noisy label introduces an undesirable yet significantly large deviation between

$$F^*_L(p_c) \text{ and } F_L(p_c)$$

Let $L(x; t)$ be the loss of an example at a given time step t . For a particular sample x , let $H_x(T)$

denote the loss history for that example that stores the loss values over T time steps. This loss history is denoted by $H_x(T) = \{L(x; t_1); L(x; t_2), \dots, L(x; T)\}$ where T is the total number of epochs the model is trained on. G is the number of classes. The refurbish score for sample x can be formulated as:

$$S(x) = \frac{\frac{1}{T} \sum_{t=1}^T \left\{ \mathcal{L}(x, t) - \left(-\log \frac{1}{G} \right) \right\}}{\text{Std}\{H_x(T)\}} \quad (5)$$

Such a design is based on the hypothesis that if a training example has a high confidence in prediction, for instance, with $p_c(x)$ close to 0 or 1, while taking a high cost consistently across the course of training, it is more likely that this example has the ground truth incorrectly labelled. The numerator in Eq. (5) captures the degree of confidence and its denominator captures the consistency in the magnitude of the cost. Overall, examples with an incorrect ground truth tend to have a higher $S(x)$ than others. Therefore, a hyper-parameter K is introduced (that is different from “ K ” previously used to denote the number of classes of abnormalities) that captures the top K % examples with the highest $S(x)$. Naturally, decreasing K reduces the number labels to be corrected while increasing the chance that a selected example is truly mis-labelled in ground truth. For all examples selected, their label is corrected by $y = \arg \max_c p_c(x)$.

An evaluation was conducted on 4 public chest X-ray datasets. Quantitative results are summarized in Table 1 that presents test AUCs on the 4 datasets with (5%, 10%, 15%, 20%) and without (0%) training label correction. For each choice of percentage K , the performance of focal loss (FOC) is shown with the best hyper-parameter. BCE is a special case of focal loss with $\gamma=0$. The best AUCs are in bold and the worst ones are underlined. It is clear that without label correction ($K=0$), FOC performs the worst. Label correction ($K>0$) is necessary to achieve the best performance for all 4 datasets.

TABLE 1

K % of labels corrected	Loss	NIH	MIMIC	Padchest	Chexpert
0%	BCE	0.7208 ± 0.0047	0.8041 ± 0.0041	<u>0.7971</u> ± 0.0042	0.8086 ± 0.0041
	FOC	<u>0.6701</u> ± 0.0049	<u>0.7382</u> ± 0.0046	0.8120 ± 0.0040	<u>0.7108</u> ± 0.0047
5%	BCE	0.7004 ± 0.0048	0.8229 ± 0.0039	0.8361 ± 0.0038	0.8158 ± 0.0040
	FOC	0.7101 ± 0.0047	0.8327 ± 0.0038	0.8224 ± 0.0039	0.8172 ± 0.0040
10%	BCE	0.7048 ± 0.0048	0.8325 ± 0.0038	0.8354 ± 0.0038	0.7939 ± 0.0042
	FOC	0.7021 ± 0.0048	0.8305 ± 0.0038	0.8215 ± 0.0039	0.7874 ± 0.0042
15%	BCE	0.7281 ± 0.0047	0.8364 ± 0.0038	0.8252 ± 0.0039	0.7197 ± 0.0047
	FOC	0.7209 ± 0.0047	0.8194 ± 0.0039	0.8237 ± 0.0039	0.8203 ± 0.0039
20%	BCE	0.7116 ± 0.0047	0.7639 ± 0.0044	0.8247 ± 0.0039	0.8327 ± 0.0038
	FOC	0.7024 ± 0.0048	0.8357 ± 0.0038	0.8091 ± 0.0040	0.7513 ± 0.0045

In further examples, the medical scan viewing system **3100** also operates to: determine a subset of the set of abnormality classes are present in the new medical scan in response to a corresponding subset of the set of global probability values comparing favorably to a corresponding set of probability thresholds; and transmit, via the transmitter, abnormality data that indicates the subset of the set of abnormality classes to the client device for display via a display device. The size of the subset of the set of abnormality classes determined to be present in the new medical

scan can be greater than one. At least two of the set of probability thresholds can be different values.

In various embodiments, abnormality correlation data corresponding to the set of abnormality classes is generated in conjunction with training the computer vision model, wherein generating the global probability data utilizes the abnormality correlation data, and wherein an additional abnormality class is added to the subset of the set of abnormality classes in response to the abnormality correlation data indicating that a correlation between the additional abnormality class and at least one of the subset of the set of abnormality classes comparing favorably to a correlation threshold. The operational instructions, when executed by the at least one processor, further cause the medical scan viewing system **3100** to determine a region of interest corresponding to each of the subset of the set of abnormality classes based on the probability matrix data, wherein the abnormality data further includes the region of interest. An interface can be displayed by the display device, wherein the interface displays the new medical scan, and wherein the interface further indicates the region of interest in response to receiving the abnormality data.

While primarily described above in terms of generating global probability values, the medical scan annotating system **2612** and/or other elements of the medical scan viewing system **3100** can further operate as a multi-label heat map generating system. Heat map visualization data is generated, for example, by performing a heat map generator function on the probability matrix data. In particular, the heat map visualization data can indicate a heat map for each of the K abnormality classes, based on their corresponding $N \times N$ probability matrix. Each heat map can indicate pixel values or other color values, corresponding to grayscale and/or RGB color values, corresponding to each pixel of the input image data. In some embodiments, pixel values and/or other color values are only indicated for each image patch of the highest resolution, for example, where a single color value is computed for each of the values of the $N \times N$ probability matrix for each of the K classes. In some embodiments, heat maps are generated for each of the resolution layers, for

example, where a single color value is computed for each image patch of the corresponding resolution layer.

The pixel values of each heat map, such as the image/color intensity, can be proportional to the raw probability values of the $N \times N$ probability and/or can be computed as a deterministic function of the raw probability values. This results in a $N \times N$ resolution heat map, and if displayed by the same number of pixels as the input image, results in all pixels of the same image patch being assigned the same color. This can result in borders between image patches having a dramatic shift in color. For a more visually desir-

able heat map, a smoothing function can be utilized to smooth the color transitions between image patches and/or to otherwise soften the borders between image patches by changing color values gradually within each image patch in the direction towards each of up to four borders, based on the color of the neighboring image patch in each of the up to four directions. For example, when a 64×64 dimension probability matrix is outputted for a 1024×1024 image for each abnormality class, smoothing techniques can be applied within each of the 16×16 dimension patches, for example, to smooth the borders between patches. In this case, the same image patch can include pixels of varying color intensities. Color intensity value differentials between ones of a set of initial color values of neighboring pixels included in different ones of the set of image patches can be reduced as a result of applying the smoothing function. In some embodiments, the smoothing function is different for some or all of the K abnormality classes.

Alternatively or in addition, a segmentation masking function can be applied to some or all of the heat maps to mask one or more designated or determined regions, for example, based on borders of an anatomical region. For example, the segmentation masking function can mask everything outside of the heart. Masking can include not assigning pixel values for the masked region of the heat map and/or can include setting the pixel values for the masked region of the heat map to a mask color such as black, white, or other uniform, predetermined mask color. In some embodiments, the segmentation masking function is different for heat maps of each of the K different abnormality classes, for example, based on predetermined anatomical regions the different ones of the K abnormality classes pertain to. For example, for chest x-rays, heat maps for some of the K abnormality classes can mask regions outside the lungs, for example, when the corresponding abnormality class is prevalent in the lungs. As a further example, other ones of the K abnormality classes can mask regions outside the heart, for example, when the corresponding abnormality class is prevalent in the heart.

This heat map visualization data can be transmitted to a client device for display or otherwise displayed via display device 3108. In some embodiments, the interactive interface 3110 displayed by the display device 3108 displays at least one of the heat maps for a corresponding one of the K abnormality classes. Each heat map can be displayed based on the corresponding color/intensity values for each pixel. In some embodiments, the raw pixel values of the heat map are displayed. In some embodiments, the heat map overlays the medical scan image data, where features of the original image data are still visible and the heat map highlights or shades the original image data in accordance with the color values of the heat map visualization data. The heat maps can be displayed in conjunction with text identifying the corresponding abnormality class, with the calculated global probability value for the corresponding abnormality class, and/or with the final binary identifier of the corresponding abnormality class. In some embodiments, the interface described in conjunction with the medical scan assisted review system 102 is utilized to display the heat maps and/or to allow a user to interact with the interactive interface 3110.

In various embodiments, the medical scan viewing system 3100 is operable to receive, via a receiver, a medical scan 3120 and generate a set of heat maps corresponding to the medical scan, where each of the set of heat maps corresponds to probability matrix data generated for a corresponding one of a set of abnormality classes by utilizing the medical scan 3120 as input to an inference function. The

interactive interface 3110 is generated for display on a display device 3108 associated with the medical scan viewing system 3100. A first portion of the interactive interface 3110 displays image data of the medical scan, and a second portion of the interactive interface displays at least one of the set of heat maps. The first portion of the interactive interface 3110 can be adjacent to the second portion of the interactive interface. User input to the medical scan viewing system 3100 is received via interactive interface 3110, where the user input corresponds to a selection by a user from option data presented by a third portion of the interactive interface. An updated interactive interface 3110 is generated for display on the display device, where the updated interactive interface includes a change to the display of the at least one of the set of heat maps by the second portion of the interactive interface in response to the user input.

FIG. 12B-12D are pictorial diagrams of medical scans with region labels in accordance with various embodiments. In FIG. 12B, a region label of a medical scan 3133 indicates the presence of an abnormally large lymph node based on a grouping of grid squares 3150. For example, the abnormality is indicated as being present in the portions of the medical scan 3133 within each of the individual grid squares 3150 and absent in other portions of the scan. In FIG. 12C, a region label of a medical scan 3133 indicates the presence of an abnormally large lymph node based on a polygon 3160. For example, the abnormality is indicated as being present in the portions/pixels of the medical scan 3133 within the polygon 3160 and absent in other portions/pixels of the scan. In FIG. 12D, a region label of a medical scan 3133 indicates the presence of an abnormally large lymph node based on an ellipse 3170. For example, the abnormality is indicated as being present in the portions/pixels of the medical scan 3133 within the ellipse 3170 and absent in other portions/pixels of the scan.

FIG. 12E presents a flowchart illustrating a method in accordance with various embodiments. In particular, a method is presented for use in conjunction with one or more functions and features described herein. Step 3202 includes storing a first plurality of medical scans with corresponding global labels and a second plurality of medical scans with corresponding region labels, wherein the global labels each correspond to one of a set of abnormality classes and wherein each of the region labels correspond to one of the set of abnormality classes. Step 3204 includes generating a computer vision model by training on the first plurality of medical scans with the corresponding global labels and the second plurality of medical scans with the corresponding region labels. Step 3206 includes receiving, via a receiver, a new medical scan. Step 3208 includes generating global probability data based on the computer vision model, wherein the global probability data indicates a set of global probability values corresponding to the set of abnormality classes, and wherein each of the set of global probability values indicates a probability that a corresponding one of the set of abnormality classes is present in the new medical scan. Step 3210 includes transmitting, via a transmitter, the global probability data to a client device for display via a display device.

In various embodiments, the number of medical scans in the first plurality of medical scans is greater than a number of medical scans in the second plurality of medical scans. The region labels can correspond to a set of one or more grid squares corresponding to regions of interest in each of the second plurality of medical scans. The region labels can correspond to pixel-by-pixel labels corresponding to regions of interest in each of the second plurality of medical scans.

The second plurality of medical scans can correspond to only a subset of the set of abnormality classes.

In various embodiments, the method further includes: generating testing global probability data by performing an inference function that utilizes the computer vision model on the first plurality of medical scans with the corresponding global labels, wherein the testing global probability data indicates a testing set of global probability values corresponding to the set of abnormality classes, and wherein each of the testing set of global probability values indicates a probability that a corresponding one of the set of abnormality classes is present in each of the first plurality of medical scans with the corresponding global labels; comparing the testing set of global probability values to a corresponding confidence threshold for each of the first plurality of medical scans selected based on the corresponding one of the global labels; generating an updated training data set by removing ones of the first plurality of medical scans having a corresponding one of the testing set of global probability values that compares unfavorably to the corresponding confidence threshold; and wherein generating the computer vision model further includes retraining on the updated training set. The global probability data can be generated based on probability matrix data generated by performing an inference function that utilizes the computer vision model on the new medical scan, wherein the probability matrix data includes, for each of a set of image patches of the new medical scan, a set of patch probability values corresponding to the set of abnormality classes, and wherein each of the set of patch probability values indicates a probability that a corresponding one of the set of abnormality classes is present in the each of the set of image patches.

FIG. 12F presents a flowchart illustrating a method in accordance with various embodiments. In particular, a method is presented for use in conjunction with one or more functions and features described herein. Step 3302 includes storing a plurality of medical scans with corresponding global labels, wherein the global labels each correspond to one of a set of abnormality classes. Step 3304 includes generating a computer vision model based on a training on a training data set that includes the plurality of medical scans with the corresponding global labels. Step 3306 includes generating global probability data based on the computer vision model, wherein the global probability data indicates a set of global probability values corresponding to the set of abnormality classes, and wherein each of the set of global probability values indicates a probability that a corresponding one of the set of abnormality classes is present in the new medical scan. Step 3308 includes transmitting, via a transmitter, the global probability data to a client device for display via a display device.

FIG. 12G presents a flowchart illustrating a method in accordance with various embodiments. In particular, a method is presented for use in conjunction with 3304 of FIG. 12F and/or otherwise with one or more other functions and features described herein. Step 3402 includes generating testing global probability data by performing an inference function that utilizes the computer vision model on the plurality of medical scans with the corresponding global labels, wherein the testing global probability data indicates a testing set of global probability values corresponding to the set of abnormality classes, and wherein each of the testing set of global probability values indicates a probability that a corresponding one of the set of abnormality classes is present in each of the plurality of medical scans with the corresponding global labels. Step 3404 includes comparing the testing set of global probability values to a correspond-

ing confidence threshold for each of the plurality of medical scans selected based on the corresponding one of the global labels. Step 3406 includes generating an updated training data set by correcting ones of the plurality of medical scans having a corresponding one of the testing set of global probability values that compares unfavorably to the corresponding confidence threshold. Step 3408 includes retraining the computer vision model based on the updated training set.

FIGS. 13A and 13B present example views presented by interactive interface 3110. The position and orientation of different elements of the interactive interface 3110 can be the same or different than those presented in 13A and 13B, and the features discussed in conjunction with FIGS. 13A and 13B can be utilized in different arrangements of some or all of the elements displayed by the interactive interface 3110. In particular, a heat map selection interface 3535 can be displayed in its own window in any portion of the interface, and can dynamically display different options as the user makes selections. In some embodiments, the heat map selection interface 3535 is not displayed as its own window, and selections made by the user can correspond to direct interaction with one or more heat maps displayed by the interface, interaction with the original medical scan displayed by the interface, or other interaction with the interactive interface 3110 indicating the selections from presented options or other input utilized by the interactive interface 3110 as discussed herein. Any embodiments of the heat map visualization data described in conjunction with FIG. 12A can be displayed by the interactive interface 3110. Any of the embodiments of the heat map visualization data described in conjunction with FIG. 12A can correspond to options presented to the user via the interface and/or can correspond to selection data received as user input.

FIG. 13A illustrates an example of a view of interactive interface 3110 that can be displayed by the display device of a client device, in response to receiving heat map visualization data. Interface 3110 can display some or all of the heat maps, for example, side by side in adjacent views, and/or otherwise simultaneously. In some embodiments, some or all heat maps are displayed in a table 3520 as shown in FIG. 13A. While table 3120 is depicted as a single row, with K columns, table 3520 can include a single column with K rows, and/or can include any number of rows and columns in other embodiments. In some embodiments, the interface also displays the original medical scan 3512 alongside the simultaneous display of the one or more of the heat maps. The original medical scan 3512 can be displayed statically and/or unaltered. The original medical scan 3512 can be displayed at the same size as each heat map in table 3520 for ease of comparison. Furthermore, the original medical scan 3512 can be aligned along a same horizontal axis or a same vertical axis as a row or column of the table 3520 for further ease of comparison. In some embodiments, the region of interest data generated by the medical scan viewing system 3100 can be received and presented in conjunction with display of the heat map and/or the original medical scan 3512. In some embodiments, other annotation data and/or diagnosis data generated in the inference data, for example, based on the detection step and/or the classification step, can be presented in conjunction with display of the heat map and/or the original medical scan 3512.

A heat map selection interface 3535 can be utilized to allow a user to select and/or toggle preferences for display of the table of heat maps. The user can correspond to a radiologist, a user responsible for generating and/or maintaining the computer vision model, a system administrator,

and/or another user of one or more subsystems 101. For example, the user can select from a plurality of heat map ordering criteria options, where the order of the K heat maps is determined based on the ordering criteria identified by the user to order the K heat maps. For example, the user can select to order the heat maps in descending order by their corresponding global probabilities. As another example, the user can select from a plurality of proper subset criteria options, where only a proper subset of the K heat maps that meet the selected one or more proper subset criteria options are displayed. For example, the user can select to display only heat maps with a corresponding global probability for the corresponding abnormality class that compares favorably to a probability threshold. In some embodiments, the user can select from a set of probability thresholds and/or can enter the probability threshold as a continuous value. In embodiments where heat maps are generated for multiple resolution layers, all of the resolution layers can be displayed by the table and/or each of the K heat maps are displayed at a selected resolution layer selected by the user utilizing the heat map selection interface 3535.

FIG. 13B illustrates another example of a view of interactive interface 3110 that can be displayed by the display device 3108. In some embodiments, a window 3530 of the interface is designated for display of a single one of the K heat maps, denoted as heat map X in FIG. 13C. In some embodiments, heat map X is selected in response to user selection of one of the K abnormality classes and/or one of the K heat maps themselves. For example, heat map selection interface 3535 can display a list of the K abnormality classes and/or can display the table 3520, and the user can interact with the heat map selection interface 3535 to indicate which heat map is shown. As another example, the interactive interface 3110 can change to the new view of FIG. 13C displaying window 3530 in response to selection of the one of the K heat maps from table 3520 by user interaction to the view of interface 3110 presented in FIG. 13A. For example, the table 3120 can correspond to small, thumbnail images of the K heat maps that, when selected, cause the window 3530 to display the selected heat map as a larger display. In some embodiments the heat map X is further selected based on selection of the one of the plurality of resolution layers. In some embodiments, the user can toggle between heat maps displayed in the window by changing their selection of the one of the K abnormality classes and/or resolution layers by interacting with heat map selection interface 3535. While FIG. 13B presents a single window, multiple windows can be included and can each display different heat maps.

In some embodiments, the interactive interface 3110 also displays the image data of the original medical scan 3512, and/or the image data of the medical scan as it was received by the medical scan viewing system 3100, alongside the window 3530. The original medical scan 3512 can be displayed statically and/or unaltered. The original medical scan 3512 can be displayed at the same size as the heat map X in window 3530 for ease of comparison. Furthermore, the original medical scan 3512 can be aligned along a same horizontal axis or a same vertical axis as the heat map X in window 3530 for further ease of comparison. In some embodiments, the region of interest data generated by the medical scan viewing system 3100 can be received and can be presented in conjunction with display of the heat map and/or the original medical scan 3512. In some embodiments, other annotation data and/or diagnosis data generated in the inference data, for example, based on a detection step

and/or a classification step, can be presented in conjunction with display of the heat map and/or the original medical scan 3512.

In some embodiments of interactive interface 3110 as presented in FIG. 13A, FIG. 13B, or another configuration of interactive interface 3110, the user can interact with the heat map selection interface 3535 or can otherwise interact with interactive interface 3110 to toggle the smoothing function, for example, where the user can turn smoothing on or off and/or can alter the smoothing parameters of the smoothing function. As a result, the interface can display one or more heat maps in accordance with the selected parameters and/or without any smoothing in response to the user input. In some embodiments, the medical scan viewing system 3100 receives smoothing function parameters and/or unsmoothing function parameters that can be applied to smooth an unsmoothed heat map received in the heat map visualization data and/or to unsmooth a smoothed heat map received in the heat map visualization data, respectively. For example, unsmoothing a smoothed heat map can result in the regenerating or otherwise reverting back to the original heat map before the smoothing function was applied. In other embodiments, the smoothing function is a non-reversible function, and the medical scan viewing system 3100 can receive a smoothed version and original version of each of the heat maps to enable the user to toggle between the smoothed and unsmoothed versions. In some embodiments, the medical scan viewing system 3100 can store a copy of the original unsmoothed version locally after applying the smoothing function.

Alternatively or in addition, the user can interact with the heat map selection interface 3535 or can otherwise interact with interactive interface 3110 to toggle the segmentation masking, for example, where the user can mask or unmask the region outside the anatomical region of interest in the display of one or more heat maps. In some embodiments the user can toggle between a plurality of anatomical regions by interacting with the interactive interface 3110, and as a result, the heat map will be displayed with the pixels outside the selected anatomical region masked. In some embodiments, the medical scan viewing system 3100 receives masking function parameters and/or unmasking function parameters that can be applied to mask an unmasked heat map received in the heat map visualization data and/or to unmask a masked heat map received in the heat map visualization data, respectively. For example, unmasking a masked heat map can include regenerating or otherwise reverting back to the original heat map before the masking function was applied. In other embodiments, the masking function is a non-reversible function, and the medical scan viewing system 3100 can receive an unmasked version and a masked version, or a plurality of masked versions corresponding to a plurality of different anatomical regions, of each of the heat maps to enable the user to toggle between the masked and unmasked versions. In some embodiments, the medical scan viewing system 3100 can store a copy of the original unmasked version locally after applying the masking function. The masking and smoothing can be toggled separately or simultaneously, for example, where a heat map is displayed as both masked and smoothed.

In some embodiments, for example, where each image patch corresponds to the same color/intensity value, each image patch and their corresponding probabilities are visually distinct. For example a heat map where no smoothing function was applied and/or a heat map that was unsmoothed and reverted back to its original form can have visually distinct image patches. In some embodiments, the user can

interact with window 3530 of FIG. 13B to select a particular image patch of interest. In response, the interactive interface 3110 can outline, highlight, crop, zoom in on, or otherwise indicate the corresponding image patch in the original medical scan 3512. This can enable the user to more easily inspect the features of the image that resulted in the corresponding probability matrix value of the image patch, for example, allowing the user to detect features in the original image that may have been improperly detected by the model as one of the K abnormalities and/or allowing the user to detect features in the original image that should correspond to one of the K abnormalities, but were overlooked by the model.

The user can interact with the interactive interface 3110 or otherwise interact with the client device to correct heat maps, global probabilities and/or final binary identifiers. For example, the medical scan viewing system 3100 can generate error data based on user input corresponding to errors identified by the user. In some embodiments, the user can identify errors in one or more image patches of a heat map by selecting the one or more image patches. The user can identify whether the corresponding probabilities of the one or more image patches were too high or too low. Correction data can be generated based on user override of the probability of the one or more image patches, for example, where the user indicates a binary identifier indicating whether the corresponding abnormality is present or absent, and the probability value can be replaced by the binary identifier. In some embodiments, a new, corrected probability matrix and/or heat map can be generated and/or displayed by the interface based on the user input and/or can be transmitted to another client device, and/or for transmission back to the multi-label medical scan analysis system 3002, for example to assist in retraining of the model. In some embodiments, the user can correct final binary indicators for some or all of the K abnormality classes, for transmission to the medical scan database, for transmission to another client device, and/or for transmission back to medical scan viewing 3100, for example to assist in retraining of the model.

Alternatively or in addition, the user can initiate remediation of the model via interaction with the interactive interface 3110 or otherwise interacting with the client device, for example, based on their review of heat maps for multiple medical scans. In response, the client device can transmit remediation instructions to the medical scan viewing system 3100 and/or another subsystem 101, and remediation can be performed in response, for example, by performing a remediation step. In some embodiments, the remediation instructions can include updated model parameters and/or can indicate error data and/or correction data indicating errors identified in and/or corrections made to probabilities of one or more image patches of one or more heat maps, the probability matrix, heat map, global probabilities, and/or final binary identifiers for use in retraining the model and/or other remediation.

In some embodiments, the heat map visualization data indicates a predetermined ordering for the K heat maps. For example, the K heat maps can be sorted in descending order of the calculated global probability of the corresponding abnormality class, where the heat map of the one of the K heat maps with the highest corresponding global probability value is first in the predetermined ordering. As another example, the predetermined ordering corresponds to a determined severity or time-sensitivity of the corresponding abnormality class, which can be determined based on features of the abnormality detected in the medical scan. As another example, the predetermined ordering is selected by

the user via the interface and/or is stored as user preference data corresponding to the user. In some embodiments, the predetermined ordering corresponds to a proper subset of the K classes, for example, where only heat maps for abnormality classes determined to be present in the medical scan are included in the predetermined ordering. In some embodiments, the user can override the predetermined ordering via user input to the interface.

The table 3520 can be automatically arranged based on the predetermined ordering, for example, where the first heat map of the predetermined ordering appears at the top of the table and where the last heat map of the predetermined ordering appears at the bottom of the table. As another example, the first heat map of the predetermined ordering can appear at the top-left most spot of the table and the last heat map of the predetermined ordering appears at the bottom-right most of the table. In embodiments where a single heat map is displayed by window 3530, window 3130 can display the heat maps in accordance with the predetermined ordering, one at a time, in sequence, where the window displays a next heat map in the predetermined ordering in response to user input indicating the user elects to advance to the next heat map.

In some embodiments, interface 3110 can present multiple heat maps overlapping each other in the same window 3530. For example, a single set of pixels corresponding to the size of the medical scan can present multiple heat maps simultaneously. In particular, the multiple heat maps can be presented in accordance with different color schemes, different shading patterns, different animation patterns, or can otherwise be visually distinguishable. In such embodiments, the two or more heat maps simultaneously displayed in window 3530 can correspond to the first two or more heat maps in the predetermined ordering and/or can be selected based on user input.

The discussion that follows in conjunction with FIGS. 14A-14D introduces an example embodiment of the model generated by medical scan viewing system 3100. Diagnostic imaging often requires the simultaneous identification of a multitude of findings of varied size and appearance. Beyond global indication of said findings, the prediction and display of region/localization information improves trust in and understanding of results when augmenting clinical workflow. Medical training data rarely includes more than global image-level labels as segmentations are time-consuming and expensive to collect. The example embodiment of the medical scan viewing system 3100 can utilize a novel architecture, which learns at multiple resolutions while generating saliency maps with weak supervision.

As used herein, $x \in \mathcal{R}^{w \times h \times c}$ denotes an input image with width w , height h , and channel c . In particular, x can correspond to the medical scan received by the medical scan viewing system 3100. As used herein, y is a binary vector of dimensionality K , where K is the total number of classes. In particular, K can correspond to the size of the set of abnormality classes discussed herein. For a specific class k , $y_k=0$ indicates its absence and $y_k=1$ its presence. The subscript indexes a particular example, for instance, $\{x_i; y_i\}$ is the i -th example. As used herein, $F \in \mathcal{R}^{w \times h \times c}$ denotes a feature map and $Q \in \mathcal{R}^{w \times h \times c}$ denotes a saliency map, with $Q \in [0,1]$. As used herein, two depth factors l and m accompany the feature and saliency maps. For instance, F_l is the feature map as the result of a set of nonlinear transformation that changes the spatial resolution of F_l-1 . On the other

hand, F_{m-1} and F_m are consecutive feature maps that preserve the resolution during the nonlinear transformation.

FIG. 14A illustrates an example model that can be utilized by the of the medical scan viewing system 3100. In particular, FIG. 14A illustrates an example inference function 3620, such as any of the K inference functions of medical scan annotating system 2612 of FIG. 12A. The inference function 3620 produces a saliency map with a resolution of 64×64 , illustrating the process from input X-ray image to a predicted abnormality score. To reduce the resolution, a standard ResNet is firstly applied on the input image. To preserve the resolution, a standard DenseNet is applied per resolution. Upsampling and channel-wise concatenation fuse information from multiple resolutions. LSE-LBA pooling aggregates instance scores to the global probability. Different numbers of resolution layers and/or different resolutions at each layer can be utilized in other embodiments. In some embodiments, the inference function and/or the global labeling function can be implemented by utilizing the model of FIG. 14A as discussed herein.

Each ResNet can contain several sub-modules, each of which is parameterized as $F_{l+1} = \sigma(g(F_l) + f(F_l))$. F_{l+1} can be half the resolution of F_l , and/or can have twice the number of channels as F_l . σ can be is an element-wise nonlinearity. The functions g and f can be composed of a series of 1×1 and 3×3 convolutions. The reduction in spatial resolution can be achieved by using convolutions with a stride size 2. A simple f and complex g can be chosen such that f is as close as possible to a simple identity transformation, leaving the heavy-lifting non-linear transformations to g to learn the residual. In some embodiments, spatial resolutions can be preserved with $F_{m+1} = \sigma(g(F_m) + F_m)$ in which case f is chosen to be the identity function.

Because ResNets are susceptible to over-parameterization, which becomes critical when residual connections are used repeatedly on the horizontal data row in FIG. 14A without changing the spatial resolution. In the scenario where $F_{l+1} = \sigma(g(F_l) + f(F_l))$ is applied repeatedly, a model could simply learn to ignore the capacity in g , especially when σ is a rectified linear unit (relu). This would effectively defeat the purpose of inner-resolution propagation where a model is encouraged to specialize in making predictions under a selected resolution 1. To solve this issue, the non-identity transformation on F_l can be enforced explicitly, which can include removing the residual connections. Because the resulting model would lose the attraction of being easy to optimize, DenseNets can be utilized, where the resolution-preserving transformation is formulated as $F_m = \sigma(f(F_1 \oplus F_2 \oplus \dots \oplus F_m))$, where \oplus denotes the channel-wise concatenation of feature maps and f denotes a series of resolution-preserving nonlinear transformations. This equation for F_m enforces the nonlinear transformation f on all previous feature maps without the possibility of skipping using identity mapping while still maintaining the desirable property of being easy to optimize due to the direct connections with all previous feature maps. Such a design effectively encourages the participation of all previous feature maps in propagation.

Fine-scale features, computed at high resolutions, capture detailed appearance information while coarse-scale features, computed from lower resolution representations of the data, capture semantic information and context. In deep neural networks utilized by the medical scan viewing system 3100, fine-scale features are learned in the earliest layers and coarse-scale features are learned in the subsequent layers, where the spatial resolution of the data has been reduced by repeated downsampling operations. Thus, the model learns

to construct a feature hierarchy in a fine-to-coarse manner. While the coarse-scale features at the top of typical classification neural networks are suitable for image-level classification, spatial information required to precisely localize abnormalities is likely to be lost. If the model is expected to predict not only what abnormalities are present in the image but where they are, then the spatial information must be reintegrated.

The model illustrated in FIG. 14A performs this incrementally, in a coarse-to-fine manner, by repeatedly performing the operation $F_m^l = f(\mathcal{U}(F_n^{l+1} \oplus (F_{m-1}^l)))$, where F_m^l denotes the m-th resolution-preserving feature map at resolution level 1, where F_n^{l+1} denotes the nth feature map from the lower resolution level $l+1$, where F_{m-1}^l denotes previous feature map at resolution level 1, where \mathcal{U} denotes the upsampling operation, and where \oplus denotes the channel-wise concatenation. The up sampling operation \mathcal{U} , can be implemented in various ways including bilinear interpolation, nearest-neighbors interpolation, and/or learnable transposed convolutions. In the example embodiment discussed here, nearest-neighbors can be used to implement \mathcal{U} .

Log-Sum-Exp Pooling with Lower-bounded Adaptation can be utilized to take a saliency map S of a particular class k and produces a final score p , and can be defined as follows:

$$p = LSE-LBA(S) = \frac{1}{r_0 + \exp(\beta)} \log \left\{ \frac{1}{wh} \sum_{i=1}^w \sum_{j=1}^h \exp[(r_0 + \exp(\beta))S_{i,j}] \right\}$$

As used herein, $S \in \mathbb{Q}^{w \times h \times 1}$ denotes a two-dimensional saliency map for a particular class k to be pooled. $S_{i,j}$ denotes the (i, j)-th element of S . In other embodiments, a Noisy-OR (NOR) function, generalized-mean (GM) function, and/or Log-Sum-Exponent (LSE) function can be utilized in performing the pooling function to generate the final score p . The final score p can correspond to the global probability determined for the corresponding abnormality class k . For example, a global labeling function can be implemented by utilizing the LSE-LBA function, and/or another pooling function.

In addition to maintaining the benefits of using a pooling function which balances average and max pooling, the LBE-LSA pooling function is robust to the issue of numerical underflow when $S_{i,j}$ is very close to zero, compared with other pooling functions such as NOR and GM pooling, due to the removal of the exponential that directly acts on $S_{i,j}$. LSE-LBA also preserves probabilities. By bounding the values in S to be in the range $[0; 1]$, the resulting score will also be in the same interval. Since the LSE-LBA function is monotonically increasing in $S_{i,j}$, it attains its maximum value when all $S_{i,j}=1$, and its minimum value when all $S_{i,j}=0$. When S is a map of all 0's, $LSE-LBA(S)=0$ and, and when S is a map of all 1's $LSE-LBA(S)=1$. A sigmoid activation function can be used on each $S_{i,j}$ to maintain this property. In addition to being numerically stable in computation, the LSE-LBA function reparametrizes a hyperparameter r , used in LSE pooling, with $r=r_0+\exp(\beta)$ where r_0 is a positive constant and β a learnable parameter. r can be lower bounded by r_0 , expressing the sharpness prior of the pooling function. A large r_0 can encourage the learned saliency map to have less diffuse modes.

The model of FIG. 14A can be utilized in a weakly-supervised setting where pixel-wise labels are not available and only image-level annotations are utilized. Given the

multi-resolution fused feature map at the highest level resolution $F_0 \in \mathcal{R}^{w \times h \times c}$, it is further divided into a grid of $N \times N$, with N being the chosen resolution of the final saliency map. In some embodiments, $N=w=h$, resulting in $F_0 \in \mathcal{R}^{w \times h \times c}$. Each of the N^2 c -dimensional vectors represents an instance $\text{In}(x)$ in the bag F_0 , where $n=\{1, \dots, N^2\}$. The K -class instance probability is $P(\text{In}(x))=\text{sigmoid}(W\text{In}(x))$, where W is a K by c parameter matrix that is shared among all N^2 instances. This leads to the final probabilistic saliency map $S \in \mathcal{Q}^{N \times N \times K}$. Following the LBE-LSA pooling function, $P(x)=\text{LSE-LBA}(S(x))$, where prediction $P(x)$ is a K -dimensional vector and represents, according to the probability-preserving property of LSE-LBA pooling the probability of x belonging to K classes. Hence, a multi-class cross-entropy cost can be directly computed given y .

FIG. 14B illustrates example output saliency maps at various resolutions for an input chest x-ray. The model can produce all of the saliency maps, corresponding to each of the resolution levels, or can produce the highest level saliency map only. The model of FIG. 14A can also be utilized to generate probability matrix data and/or global probability data for any other types of medical scans described herein.

The model of FIG. 14A can be applied to datasets of medical scans, such as the NIH Chest X-ray dataset, which contains 112,120 frontal-view chest X-rays taken from 30,805 patients, where 51,708 images contain at least one of 14 labeled pathologies, in a PNG format with a standardized spatial resolution of 1024×1024 . The 14 labeled pathologies can correspond to the set of abnormality classes, and can include, for example, atelectasis, effusion, mass, pneumonia, consolidation, emphysema, pleural thickening, cardiomegaly, infiltration, nodule, pneumothorax, edema, fibrosis, and/or hernia. Other clinical information including patients' age and gender are accessible in addition to the pathology labels, and while not used in this example embodiment, can be utilized in other example embodiments to train the model and/or implement the inference function.

For computational efficiency, the inputs of 1024×1024 can be downsampled to 512×512 . Data augmentation can be applied during training, for example, where each image is zoomed by a factor uniformly sampled from $[0.25; 0.75]$, translated in four directions by a factor uniformly sampled from $[-50; 50]$ pixels, and/or rotated by a factor uniformly sampled from $[-25; 25]$ degrees. After data augmentation, the inputs can be normalized to the interval $[0; 1]$. To further regularize the model, a weight decay can be applied, for example, with a coefficient of 10^{-5} .

The model can be trained from scratch using only the NIH training set, for example, with an Adam optimizer and a learning rate of 0.001. Early stopping can be performed on the validation set based on the average AUC (Area Under the ROC curve) over all of the set of pathologies. For classification, the AUC per abnormality can be utilized.

In some embodiments, no bounding boxes are used at training time so that the model remains weakly supervised with respect to the task of localization. The best models on the classification task can then be evaluated on their localization performance. The quality of localization can be determined using the metric of intersection over detected bounding boxes (IoBB) with $T(\text{IoBB})=\alpha$, where α is set at a certain threshold. IoBB can be extremely sensitive to the choice of the discretization threshold by which the predicted probability score S is binarized before being compared with ground truth bounding boxes. IoBB can be very sensitive to

the choice of a binarization threshold τ to discretize probabilistic saliency maps into binary foreground and background masks.

In some embodiments, the continuous version of DICE= $(2 \times S \times G)/(S^2+G^2)$ can be utilized as the cost function for training the model as a semantic segmentation model, where S is the probabilistic saliency map directly output by the model, and where G the ground truth binary bounding box downsampled to 512×512 , the same resolution as the model input. The DICE cost function, or another cost function, can be selected to take into account the probability while avoiding the decision of having to select the discretization threshold τ .

FIG. 14B presents a table illustrating an example of abnormality classification and weakly supervised localization performance on 14 abnormalities on the NIH Chest X-ray test set. Three models with different lower-bounded adaptation r_0 are included. In some embodiments, the impact of r_0 is much more pronounced in localization than in classification. In this example, the model is only trained on NIH data. In other embodiments, a pre-trained model, for example, trained on ImageNet without multi-resolution fusion. The bolded numbers of the table of FIG. 14B indicate the maxima other than statistical significance. Compared with classification, the choice of r_0 can have a more significant impact on abnormality localization due to their likely distinct visual appearance. For instance, when r_0 is small and the sharpness prior is weak, a model can tend to perform well on visually diffused abnormalities such as cardiomegaly, infiltration and pneumonia. As the sharpness prior is strengthened, localization of focalized and patchy abnormalities can be improved, as in the case of atelectasis and nodule. When choosing r_0 to be large, the performance of diffused abnormalities can degrade, such as atelectasis, cardiomegaly, effusion and pneumonia.

FIG. 14C includes an example of model-generated saliency maps. In particular, for each of the abnormality classes cardiomegaly, infiltration, nodule, effusion, mass, and pneumonia, FIG. 14C includes, from left to right, original images, ground truth bounding boxes, and model generated saliency maps for each of $r_0=0$, $r_0=5$, $r_0=10$, respectively. The corresponding DICE score for each model-generated saliency map **3262**, computed with respect to the ground truth, is also presented above the corresponding saliency map. FIG. 14C illustrates that increasing r_0 can result in overall sharper saliency maps. Using bounding boxes to delineate abnormalities can be limited by overestimating their true ROIs, which is illustrated in the cases of infiltration and pneumonia. As illustrated in FIG. 14C, some model findings can be incorrectly marked as false positives due to labeling noise wherein the ground-truth reader missed the finding.

FIG. 14D illustrates another example of saliency maps at multiple resolutions generated for a chest x-ray with mass by utilizing the four models, with an increasing target resolution, that were trained, for example, as discussed in conjunction with FIGS. 14A-14C, to produce the presented visualization. In particular, FIG. 14D illustrates how multi-resolution, lower-resolution maps can provide weak localization cues that are refined in higher-resolution layers. In some embodiments, only a highest resolution saliency map, such as a 64×64 resolution saliency map, is generated for an input medical scan.

It is noted that terminologies as may be used herein such as bit stream, stream, signal, etc. (or their equivalents) have been used interchangeably to describe digital information whose content corresponds to any of a number of desired

types (e.g., data, video, speech, text, graphics, audio, etc. any of which may generally be referred to as 'data').

As may be used herein, the terms "substantially" and "approximately" provide an industry-accepted tolerance for its corresponding term and/or relativity between items. For some industries, an industry-accepted tolerance is less than one percent and, for other industries, the industry-accepted tolerance is 10 percent or more. Other examples of industry-accepted tolerance range from less than one percent to fifty percent. Industry-accepted tolerances correspond to, but are not limited to, component values, integrated circuit process variations, temperature variations, rise and fall times, thermal noise, dimensions, signaling errors, dropped packets, temperatures, pressures, material compositions, and/or performance metrics. Within an industry, tolerance variances of accepted tolerances may be more or less than a percentage level (e.g., dimension tolerance of less than $\pm 1\%$). Some relativity between items may range from a difference of less than a percentage level to a few percent. Other relativity between items may range from a difference of a few percent to magnitude of differences.

As may also be used herein, the term(s) "configured to", "operably coupled to", "coupled to", and/or "coupling" includes direct coupling between items and/or indirect coupling between items via an intervening item (e.g., an item includes, but is not limited to, a component, an element, a circuit, and/or a module) where, for an example of indirect coupling, the intervening item does not modify the information of a signal but may adjust its current level, voltage level, and/or power level. As may further be used herein, inferred coupling (i.e., where one element is coupled to another element by inference) includes direct and indirect coupling between two items in the same manner as "coupled to".

As may even further be used herein, the term "configured to", "operable to", "coupled to", or "operably coupled to" indicates that an item includes one or more of power connections, input(s), output(s), etc., to perform, when activated, one or more its corresponding functions and may further include inferred coupling to one or more other items. As may still further be used herein, the term "associated with", includes direct and/or indirect coupling of separate items and/or one item being embedded within another item.

As may be used herein, the term "compares favorably", indicates that a comparison between two or more items, signals, etc., provides a desired relationship. For example, when the desired relationship is that signal 1 has a greater magnitude than signal 2, a favorable comparison may be achieved when the magnitude of signal 1 is greater than that of signal 2 or when the magnitude of signal 2 is less than that of signal 1. As may be used herein, the term "compares unfavorably", indicates that a comparison between two or more items, signals, etc., fails to provide the desired relationship.

As may be used herein, one or more claims may include, in a specific form of this generic form, the phrase "at least one of a, b, and c" or of this generic form "at least one of a, b, or c", with more or less elements than "a", "b", and "c". In either phrasing, the phrases are to be interpreted identically. In particular, "at least one of a, b, and c" is equivalent to "at least one of a, b, or c" and shall mean a, b, and/or c. As an example, it means: "a" only, "b" only, "c" only, "a" and "b", "a" and "c", "b" and "c", and/or "a", "b", and "c".

As may also be used herein, the terms "processing module", "processing circuit", "processor", "processing circuitry", and/or "processing unit" may be a single processing device or a plurality of processing devices. Such a process-

ing device may be a microprocessor, micro-controller, digital signal processor, microcomputer, central processing unit, field programmable gate array, programmable logic device, state machine, logic circuitry, analog circuitry, digital circuitry, and/or any device that manipulates signals (analog and/or digital) based on hard coding of the circuitry and/or operational instructions. The processing module, module, processing circuit, processing circuitry, and/or processing unit may be, or further include, memory and/or an integrated memory element, which may be a single memory device, a plurality of memory devices, and/or embedded circuitry of another processing module, module, processing circuit, processing circuitry, and/or processing unit. Such a memory device may be a read-only memory, random access memory, volatile memory, non-volatile memory, static memory, dynamic memory, flash memory, cache memory, and/or any device that stores digital information. Note that if the processing module, module, processing circuit, processing circuitry, and/or processing unit includes more than one processing device, the processing devices may be centrally located (e.g., directly coupled together via a wired and/or wireless bus structure) or may be distributedly located (e.g., cloud computing via indirect coupling via a local area network and/or a wide area network). Further note that if the processing module, module, processing circuit, processing circuitry and/or processing unit implements one or more of its functions via a state machine, analog circuitry, digital circuitry, and/or logic circuitry, the memory and/or memory element storing the corresponding operational instructions may be embedded within, or external to, the circuitry comprising the state machine, analog circuitry, digital circuitry, and/or logic circuitry. Still further note that, the memory element may store, and the processing module, module, processing circuit, processing circuitry and/or processing unit executes, hard coded and/or operational instructions corresponding to at least some of the steps and/or functions illustrated in one or more of the FIGS. Such a memory device or memory element can be included in an article of manufacture.

One or more embodiments have been described above with the aid of method steps illustrating the performance of specified functions and relationships thereof. The boundaries and sequence of these functional building blocks and method steps have been arbitrarily defined herein for convenience of description. Alternate boundaries and sequences can be defined so long as the specified functions and relationships are appropriately performed. Any such alternate boundaries or sequences are thus within the scope and spirit of the claims. Further, the boundaries of these functional building blocks have been arbitrarily defined for convenience of description. Alternate boundaries could be defined as long as the certain significant functions are appropriately performed. Similarly, flow diagram blocks may also have been arbitrarily defined herein to illustrate certain significant functionality.

To the extent used, the flow diagram block boundaries and sequence could have been defined otherwise and still perform the certain significant functionality. Such alternate definitions of both functional building blocks and flow diagram blocks and sequences are thus within the scope and spirit of the claims. One of average skill in the art will also recognize that the functional building blocks, and other illustrative blocks, modules and components herein, can be implemented as illustrated or by discrete components, application specific integrated circuits, processors executing appropriate software and the like or any combination thereof.

In addition, a flow diagram may include a “start” and/or “continue” indication. The “start” and “continue” indications reflect that the steps presented can optionally be incorporated in or otherwise used in conjunction with one or more other routines. In addition, a flow diagram may include an “end” and/or “continue” indication. The “end” and/or “continue” indications reflect that the steps presented can end as described and shown or optionally be incorporated in or otherwise used in conjunction with one or more other routines. In this context, “start” indicates the beginning of the first step presented and may be preceded by other activities not specifically shown. Further, the “continue” indication reflects that the steps presented may be performed multiple times and/or may be succeeded by other activities not specifically shown. Further, while a flow diagram indicates a particular ordering of steps, other orderings are likewise possible provided that the principles of causality are maintained.

The one or more embodiments are used herein to illustrate one or more aspects, one or more features, one or more concepts, and/or one or more examples. A physical embodiment of an apparatus, an article of manufacture, a machine, and/or of a process may include one or more of the aspects, features, concepts, examples, etc. described with reference to one or more of the embodiments discussed herein. Further, from figure to figure, the embodiments may incorporate the same or similarly named functions, steps, modules, etc. that may use the same or different reference numbers and, as such, the functions, steps, modules, etc. may be the same or similar functions, steps, modules, etc. or different ones.

Unless specifically stated to the contra, signals to, from, and/or between elements in a FIG. of any of the FIGs. presented herein may be analog or digital, continuous time or discrete time, and single-ended or differential. For instance, if a signal path is shown as a single-ended path, it also represents a differential signal path. Similarly, if a signal path is shown as a differential path, it also represents a single-ended signal path. While one or more particular architectures are described herein, other architectures can likewise be implemented that use one or more data buses not expressly shown, direct connectivity between elements, and/or indirect coupling between other elements as recognized by one of average skill in the art.

The term “module” is used in the description of one or more of the embodiments. A module implements one or more functions via a device such as a processor or other processing device or other hardware that may include or operate in association with a memory that stores operational instructions. A module may operate independently and/or in conjunction with software and/or firmware. As also used herein, a module may contain one or more sub-modules, each of which may be one or more modules.

As may further be used herein, a computer readable memory includes one or more memory elements. A memory element may be a separate memory device, multiple memory devices, or a set of memory locations within a memory device. Such a memory device may be a read-only memory, random access memory, volatile memory, non-volatile memory, static memory, dynamic memory, flash memory, cache memory, and/or any device that stores digital information. The memory device may be in a form a solid-state memory, a hard drive memory, cloud memory, thumb drive, server memory, computing device memory, and/or other physical medium for storing digital information.

While particular combinations of various functions and features of the one or more embodiments have been

expressly described herein, other combinations of these features and functions are likewise possible. The present disclosure is not limited by the particular examples disclosed herein and expressly incorporates these other combinations.

What is claimed is:

1. A global multi-label generating system, comprising:
 - at least one processor; and
 - a memory that stores operational instructions that, when executed by the at least one processor, cause the multi-label generating system to:
 - store a first plurality of medical scans with corresponding global labels and a second plurality of medical scans with corresponding region labels, wherein the global labels each correspond to one of a set of abnormality classes and wherein each of the region labels correspond to one of the set of abnormality classes, and wherein the region labels correspond to a set of one or more grid squares corresponding to regions of interest in each of the second plurality of medical scans;
 - generate a computer vision model by training on the first plurality of medical scans with the corresponding global labels and the second plurality of medical scans with the corresponding region labels;
 - receive, via a receiver, a new medical scan;
 - generate global probability data based on the computer vision model, wherein the global probability data indicates a set of global probability values corresponding to the set of abnormality classes, and wherein each of the set of global probability values indicates a probability that a corresponding one of the set of abnormality classes is present in the new medical scan; and
 - transmit, via a transmitter, the global probability data to a client device for display via a display device.
2. The multi-label generating system of claim 1, wherein a number of medical scans in the first plurality of medical scans is greater than a number of medical scans in the second plurality of medical scans.
3. The multi-label generating system of claim 1, wherein the second plurality of medical scans correspond to only a subset of the set of abnormality classes.
4. The multi-label generating system of claim 1, wherein the operational instructions, when executed by the at least one processor, further cause the global multi-label generating system to:
 - generate testing global probability data by performing an inference function that utilizes the computer vision model on the first plurality of medical scans with the corresponding global labels, wherein the testing global probability data indicates a testing set of global probability values corresponding to the set of abnormality classes, and wherein each of the testing set of global probability values indicates a probability that a corresponding one of the set of abnormality classes is present in each of the first plurality of medical scans with the corresponding global labels;
 - compare the testing set of global probability values to a corresponding confidence threshold for each of the first plurality of medical scans selected based on the corresponding one of the global labels;
 - generate an updated training data set by removing ones of the first plurality of medical scans having a corresponding one of the testing set of global probability values that compares unfavorably to the corresponding confidence threshold; and

wherein generating the computer vision model further includes retraining on the updated training set.

5 **5.** The multi-label generating system of claim **1**, wherein the global probability data is generated based on probability matrix data generated by performing an inference function that utilizes the computer vision model on the new medical scan, wherein the probability matrix data includes, for each of a set of image patches of the new medical scan, a set of patch probability values corresponding to the set of abnormality classes, and wherein each of the set of patch probability values indicates a probability that a corresponding one of the set of abnormality classes is present in the each of the set of image patches.

10 **6.** The multi-label generating system of claim **5**, wherein the operational instructions, when executed by the at least one processor, further cause the global multi-label generating system to:

determine a subset of the set of abnormality classes are present in the new medical scan in response to a corresponding subset of the set of global probability values comparing favorably to a corresponding set of probability thresholds; and

transmit, via the transmitter, abnormality data that indicates the subset of the set of abnormality classes to the client device for display via the display device.

15 **7.** The multi-label generating system of claim **6**, wherein a size of the subset of the set of abnormality classes determined to be present in the new medical scan is greater than one.

20 **8.** The multi-label generating system of claim **6**, wherein at least two of the set of probability thresholds are different values.

25 **9.** The multi-label generating system of claim **6**, wherein abnormality correlation data corresponding to the set of abnormality classes is generated in conjunction with training the computer vision model, wherein generating the global probability data utilizes the abnormality correlation data, and wherein an additional abnormality class is added to the subset of the set of abnormality classes in response to the abnormality correlation data indicating that a correlation between the additional abnormality class and at least one of the subset of the set of abnormality classes comparing favorably to a correlation threshold.

30 **10.** The multi-label generating system of claim **6**, wherein the operational instructions, when executed by the at least one processor, further cause the global multi-label generating system to:

determine a region of interest corresponding to each of the subset of the set of abnormality classes based on the probability matrix data, wherein the abnormality data further includes the region of interest.

35 **11.** The multi-label generating system of claim **10**, wherein an interface is displayed by the display device, wherein the interface displays the new medical scan, and wherein the interface further indicates the region of interest in response to receiving the abnormality data.

12. A method, comprising:

storing a first plurality of medical scans with corresponding global labels and a second plurality of medical scans with corresponding region labels, wherein the global labels each correspond to one of a set of abnormality classes and wherein each of the region labels correspond to one of the set of abnormality classes, and wherein the region labels correspond to pixel-by-pixel labels corresponding to regions of interest in each of the second plurality of medical scans;

generating a computer vision model by training on the first plurality of medical scans with the corresponding global labels and the second plurality of medical scans with the corresponding region labels;

receiving, via a receiver, a new medical scan;

generating global probability data based on the computer vision model, wherein the global probability data indicates a set of global probability values corresponding to the set of abnormality classes, and wherein each of the set of global probability values indicates a probability that a corresponding one of the set of abnormality classes is present in the new medical scan; and transmitting, via a transmitter, the global probability data to a client device for display via a display device.

10 **13.** The method of claim **12**, wherein a number of medical scans in the first plurality of medical scans is greater than a number of medical scans in the second plurality of medical scans.

15 **14.** The method of claim **12**, wherein the second plurality of medical scans correspond to only a subset of the set of abnormality classes.

15. The method of claim **12**, further comprising:

generating testing global probability data by performing an inference function that utilizes the computer vision model on the first plurality of medical scans with the corresponding global labels, wherein the testing global probability data indicates a testing set of global probability values corresponding to the set of abnormality classes, and wherein each of the testing set of global probability values indicates a probability that a corresponding one of the set of abnormality classes is present in each of the first plurality of medical scans with the corresponding global labels;

comparing the testing set of global probability values to a corresponding confidence threshold for each of the first plurality of medical scans selected based on the corresponding one of the global labels;

generating an updated training data set by removing ones of the first plurality of medical scans having a corresponding one of the testing set of global probability values that compares unfavorably to the corresponding confidence threshold; and

wherein generating the computer vision model further includes retraining on the updated training set.

20 **16.** The method of claim **12**, wherein the global probability data is generated based on probability matrix data generated by performing an inference function that utilizes the computer vision model on the new medical scan, wherein the probability matrix data includes, for each of a set of image patches of the new medical scan, a set of patch probability values corresponding to the set of abnormality classes, and wherein each of the set of patch probability values indicates a probability that a corresponding one of the set of abnormality classes is present in the each of the set of image patches.